

Part number:

**096-10088**

**HYDROMA**

HYDRAULICKÉ SYSTÉMY

**HIDROMA  
SISTEMS**

UKŁADY HYDRAULICZNE

**HYDROMA**

ГИДРАВЛИЧЕСКИЕ СИСТЕМЫ



# PCM5

## TWO-WAY PRESSURE COMPENSATOR WITH FIXED ADJUSTMENT

SERIES 11

### MODULAR VERSION

ISO 4401-05 (CETOP 05)

**p** max 320 bar

**Q** max 100 l/min

### MOUNTING INTERFACE

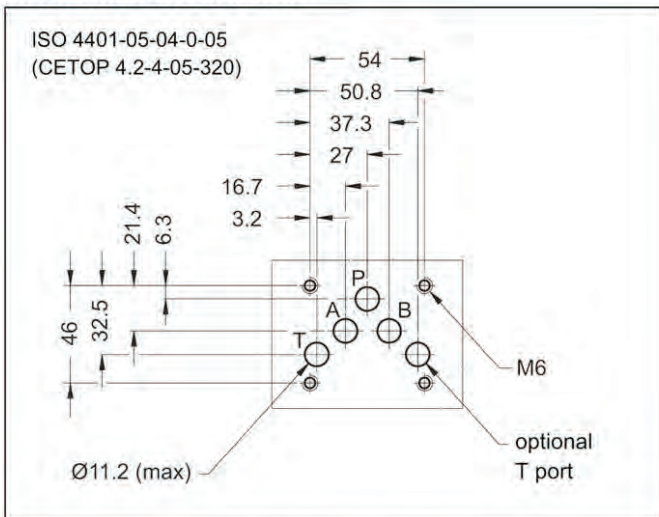

### OPERATING PRINCIPLE

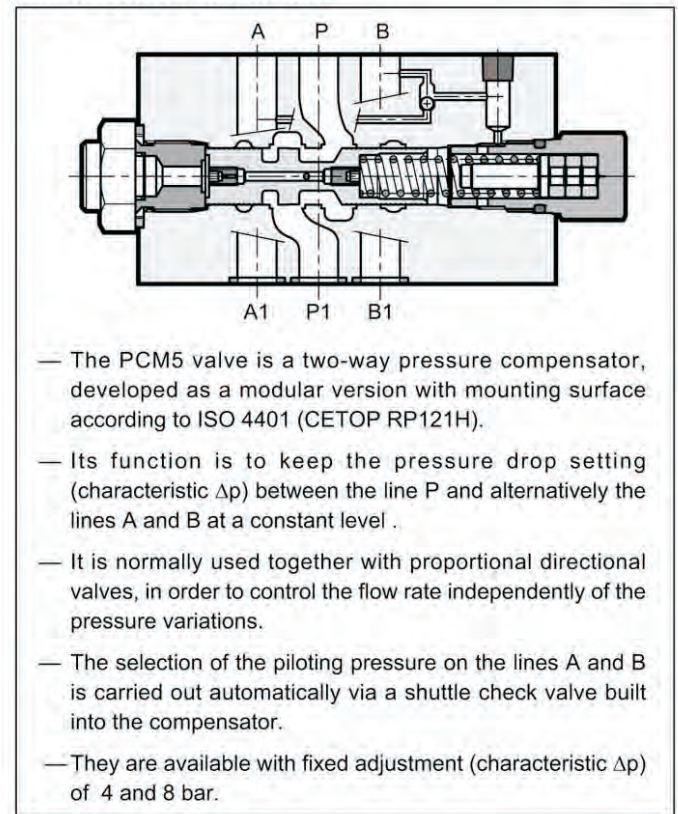

### APPLICATION EXAMPLES

Compensator combined with a proportional valve type DSE5-A\*

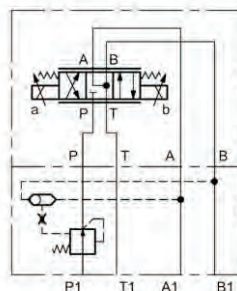

### PERFORMANCES (working with mineral oil of viscosity of 36 cSt at 50°C)

Max operating pressure	bar	320
Characteristic $\Delta p$ :	bar	4 - 8
Max flow rate	l/min	100
Ambient temperature range	°C	-20 / +50
Fluid temperature range	°C	-20 / +80
Fluid viscosity range	cSt	10 ÷ 400
Fluid contamination degree	According to ISO 4406:1999 class 20/18/15	
Recommended viscosity	cSt	25
Mass	kg	2,7

### HYDRAULIC SYMBOL

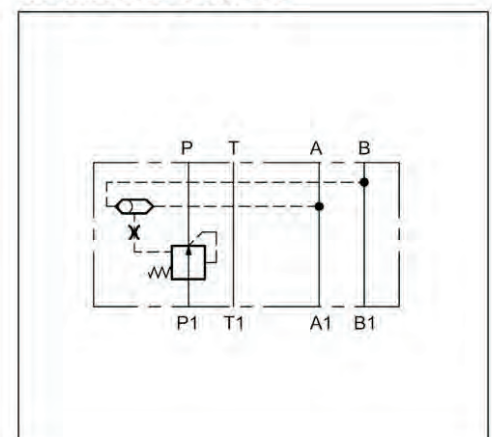

## 1 - IDENTIFICATION CODE

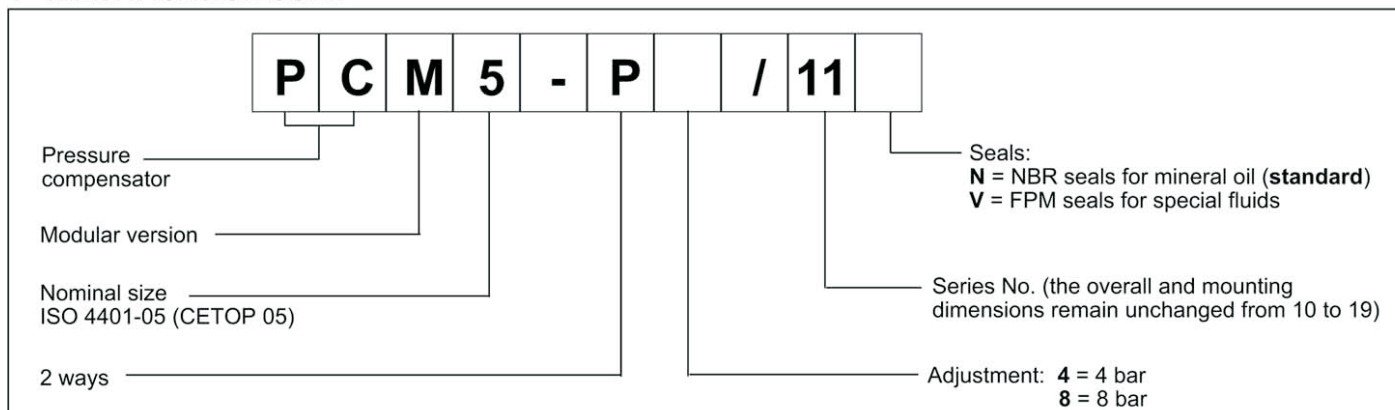

## 2 - CHARACTERISTIC CURVES (values obtained with viscosity of 36 cSt at 50°C)

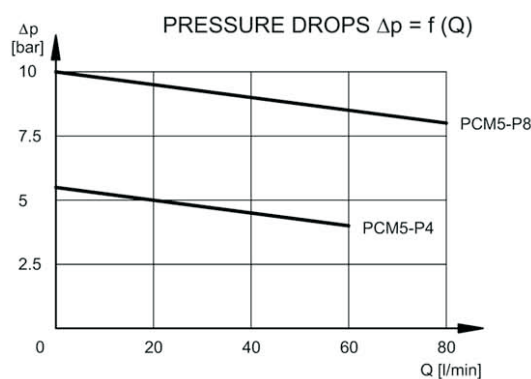
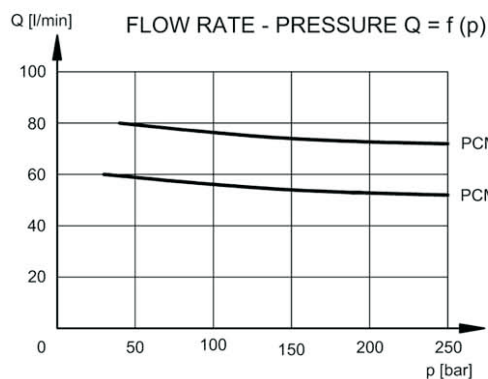

## 3 - HYDRAULIC FLUIDS

Use mineral oil-based hydraulic fluids HL or HM type, according to ISO 6743-4. For these fluids, use NBR seals. For fluids HFDR type (phosphate esters) use FPM seals (code V). For the use of other kinds of fluid such as HFA, HFB, HFC, please consult our technical department. Using fluids at temperatures higher than 80 °C causes a faster degradation of the fluid and of the seals characteristics. The fluid must be preserved in its physical and chemical characteristics.

## 4 - OVERALL AND MOUNTING DIMENSIONS

