

Part number:

006-10193

HYDROMA

HYDRAULICKÉ SYSTÉMY

**HIDROMA
SYSTEMS**

UKŁADY HYDRAULICZNE

HYDROMA

ГИДРАВЛИЧЕСКИЕ СИСТЕМЫ

**MASSIMA PRESSIONE, DIRETTE, OTTURATORE CONICO
DIRECT, POPPET TYPE RELIEF**

VS-80

04.11.05 - X - Y - Z

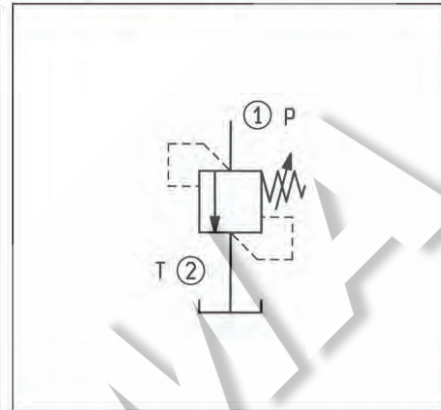
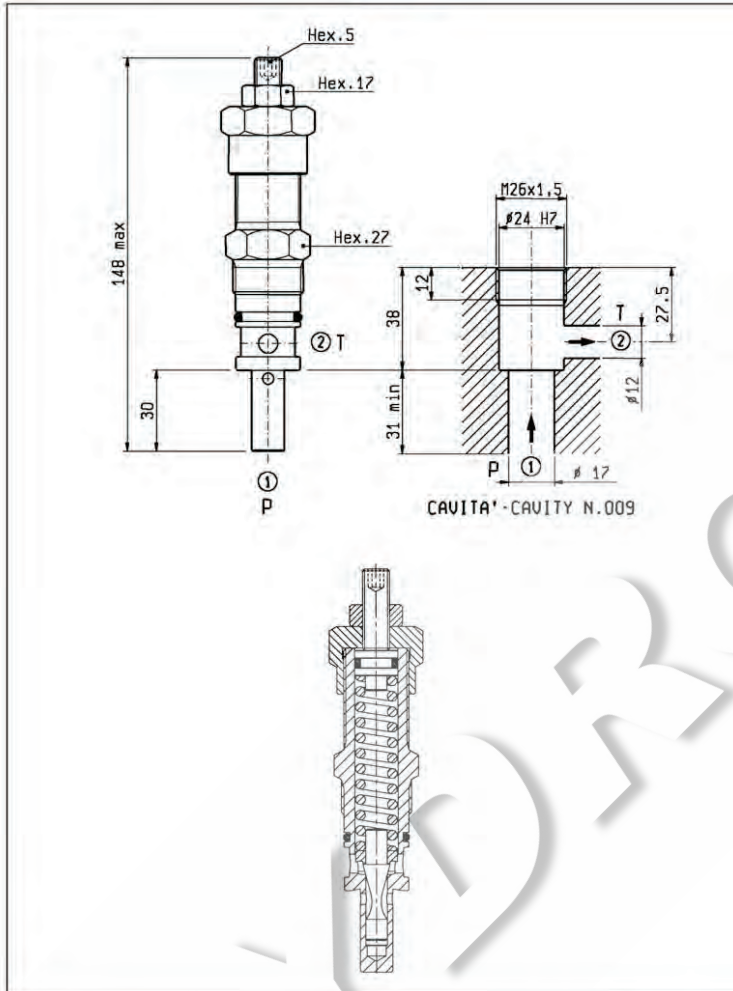

DATI TECNICI / TECHNICAL DATA

Coppia di serraggio Installation torque	83-92 Nm
Pressione di lavoro max. Max. working pressure	250 bar
Portata max. Flow max.	80 l/min
Peso Weight	0.35 kg

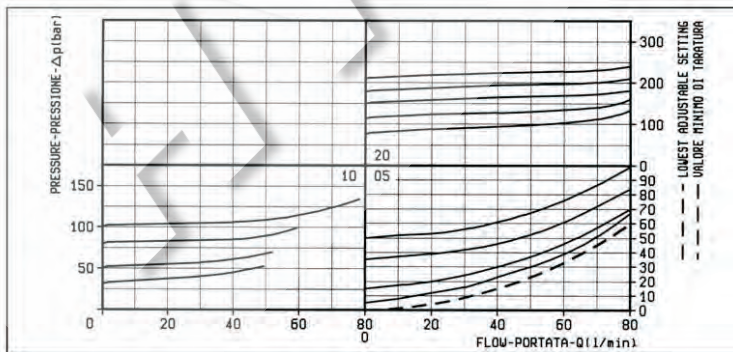

X	REGOLAZIONI ADJUSTMENTS	
03	vite esterna esagono incassato leakproof hex. socket screw	
04	volantino e dado handknob and locknut	
	cappello per piombatura sealing cap codice / ordering code 03.05.01.001	

MOLLE / SPRINGS					
Z	Campo taratura min - max bar Adj. press. range bar	Incremento press. bar / giro vite Press. increase bar / turn	Taratura standard bar (Q = 5 l/min) Std. setting bar (Q = 5 l/min)	Cod. ordinazione Ordering code	Colore Colour
05	5-50	6	50	03.51.01.020	nero black
10	35-100	12	100	03.51.01.001	blu blue
20	80-250	27	200	03.51.01.010	rosso red

Y		ATTACCHI / PORT SIZE
99		Cartuccia/Cartridge