

Part number:

096-10336

HYDROMA

HYDRAULICKÉ SYSTÉMY

**HIDROMA
SYSTEMS**

UKŁADY HYDRAULICZNE

HYDROMA

ГИДРАВЛИЧЕСКИЕ СИСТЕМЫ



RPC1

PRESSURE AND TEMPERATURE COMPENSATED FLOW CONTROL VALVE SERIES 41

SUBPLATE MOUNTING:

CETOP 03

p max **250** bar

Q max (see performance ratings table)

MOUNTING INTERFACE

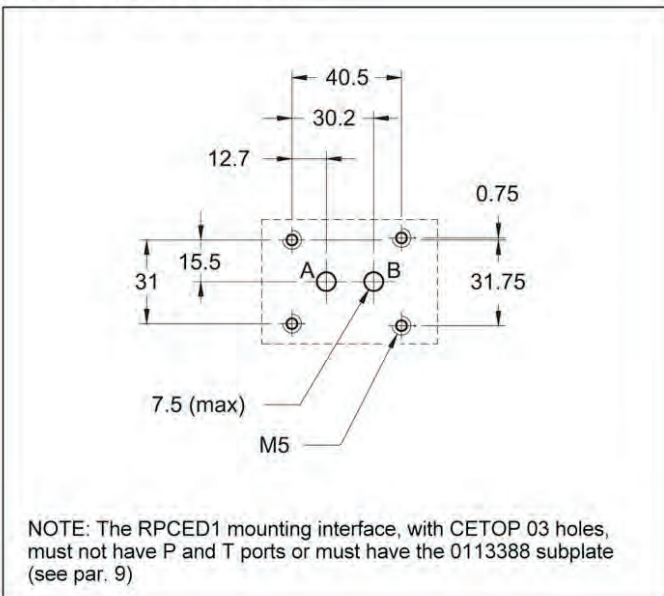

OPERATING PRINCIPLE

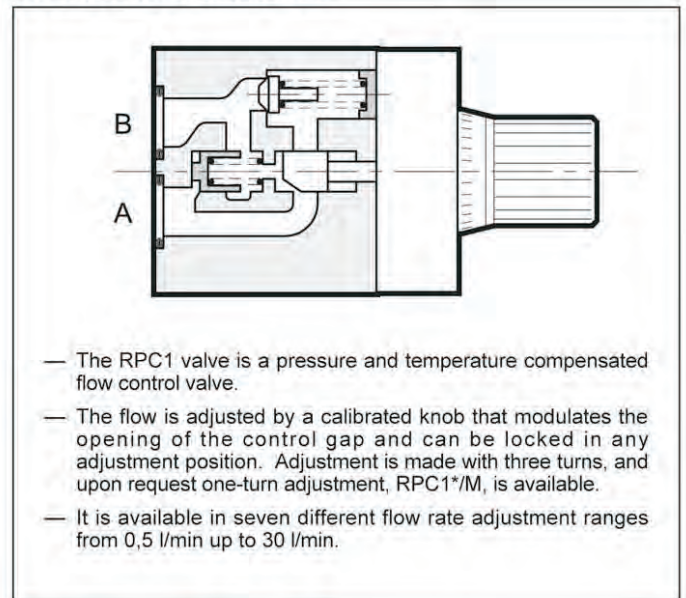

PERFORMANCE RATINGS (obtained with mineral oil with viscosity of 36 cSt at 50°C)

Maximum operating pressure	bar	250
Minimum pressure difference between A and B	bar	10
Check valve cracking pressure	bar	0,5
Maximum controlled flow rates	l/min	0,5-1-4-10-16-22-30
Minimum controlled flow rate (for 0,5 - 1 and 4 l/min)	l/min	0,025
Maximum flow rate in free flow direction	l/min	40
Ambient temperature range	°C	-20 ÷ +50
Fluid temperature range	°C	-20 ÷ +70
Fluid viscosity range	cSt	2,8 ÷ 380
Recommended filtration	µm absolute	≤ 25
Recommended filtration for < 0,5 l/min flow rates	µm absolute	≤ 10
Recommended viscosity	cSt	25
Mass	kg	1,3
Number of adjustment knob turns	RPC1	3
	RPC1-*/M	1

HYDRAULIC SYMBOLS

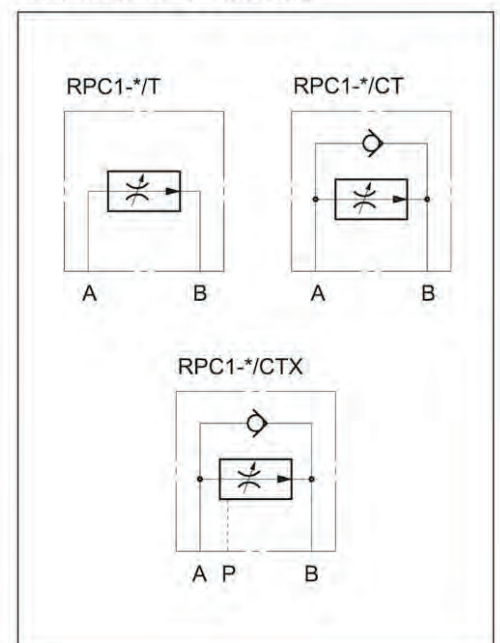

1 - IDENTIFICATION CODE

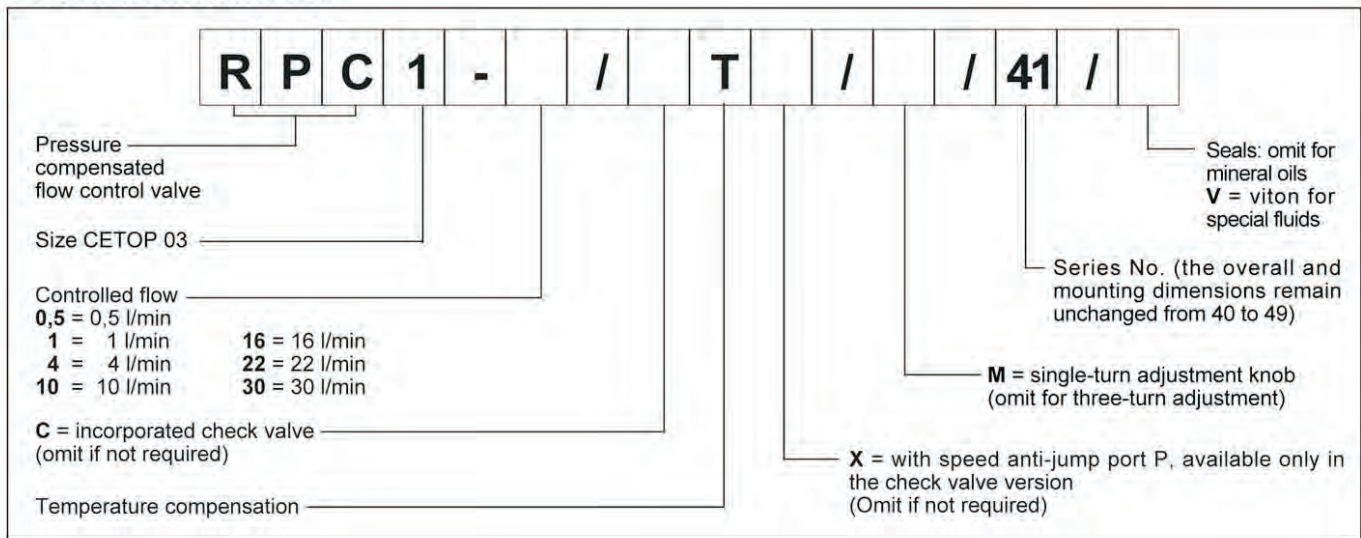

2 - CHARACTERISTIC CURVES (values obtained with viscosity of 36 cSt at 50°C)

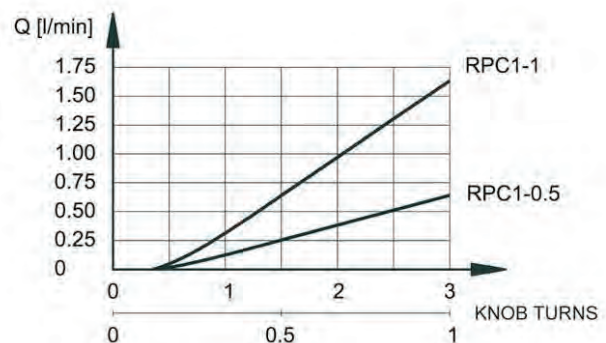
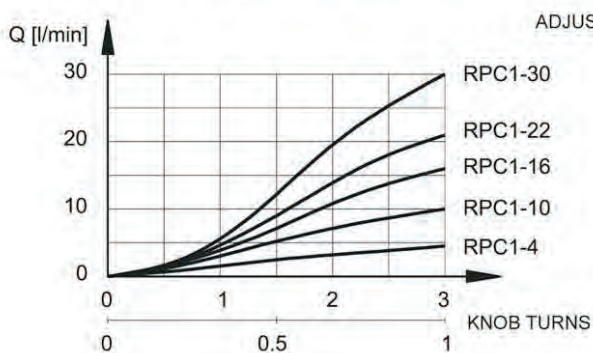

3 - HYDRAULIC FLUIDS

Use mineral oil-based hydraulic fluids, with the addition of suitable anti-frothing and anti-oxidizing agents. For the use of other types (water glycol, phosphate esters and others), please consult our technical department.

4 - PRESSURE COMPENSATION

Two throttles in series are in the valve. The first is an opening regulated by the knob; the second, piloted by the pressure upstream and downstream of the first throttle, assures a constant pressure drop across the adjustable throttle. In these conditions, the set flow rate value stays constant within a tolerance range of $\pm 2\%$ of the maximum flow controlled by the valve for maximum pressure variation between the intake and outlet chambers of the valve.

5 - TEMPERATURE COMPENSATION

The valve temperature compensation is obtained with the principle of fluid passage across a thin wall orifice in which the flow rate is not substantially influenced by the oil viscosity fluctuations. For controlled flows of less than 0,5 l/min and with a temperature difference of 50 °C, flow is increased by about 13% of the set flow value. For higher flow rates, and with the same temperature difference, the flow increase is about 4% of the maximum flow controlled by the valve.

6 - REVERSE FREE FLOW

The RPC1 valve, upon request, is supplied with an incorporated check valve to allow free flow in the direction opposite to the controlled flow, B→A. In this case the valve code becomes RPC1-*/CT.

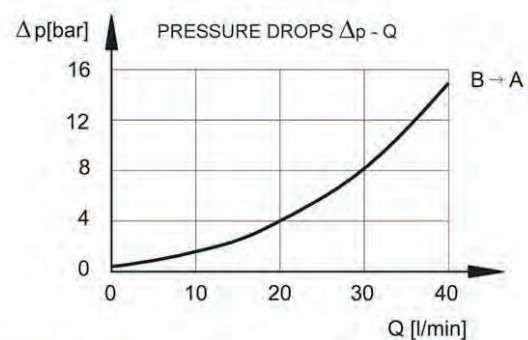

7 - RPC1-*/CTX

This valve is normally used for intake control and is positioned downstream of the directional valve. The piloting connection "P" keeps the compensator in the closed position, thus avoiding the initial speed jump that occurs at the time the distributor sends oil to the valve (see the application diagram, paragraph 11).

8 - RPC1-* OVERALL AND MOUNTING DIMENSIONS

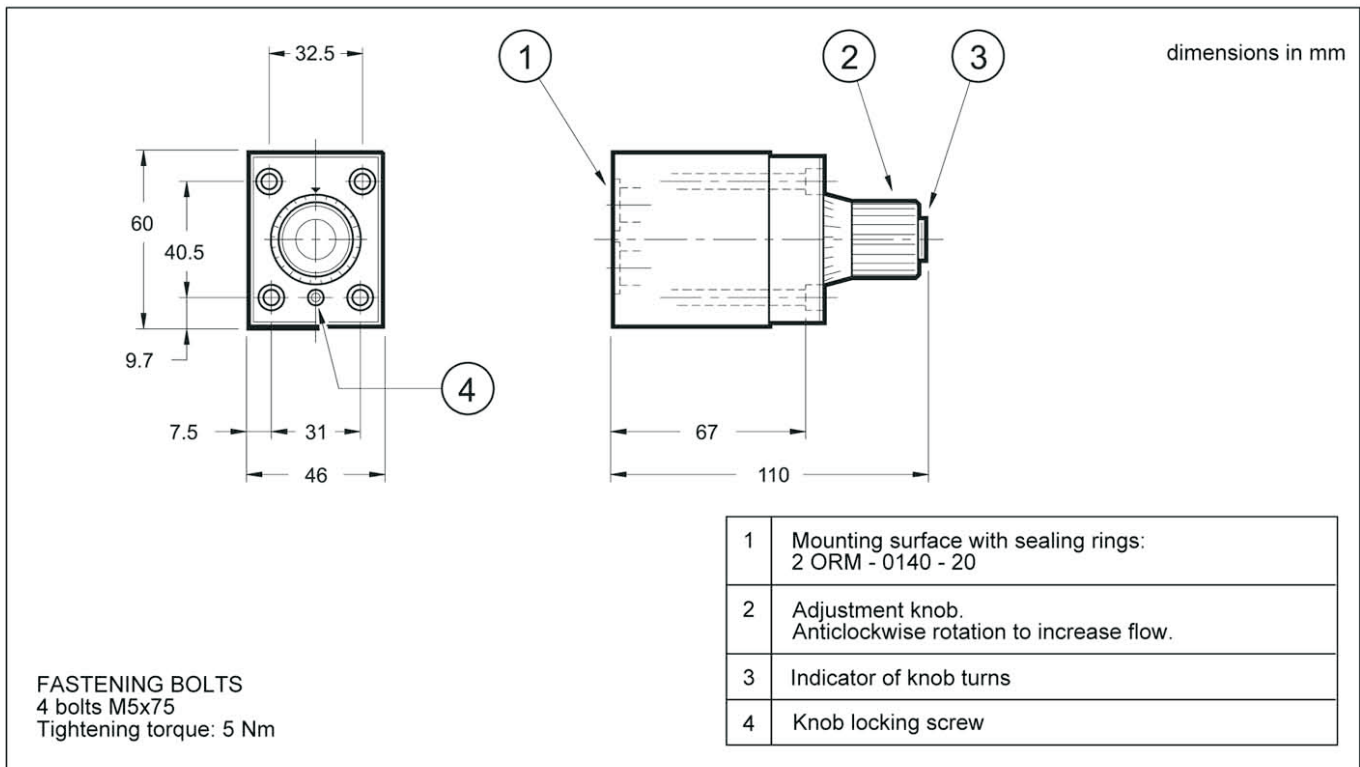

9 - RPC1-*/CTX OVERALL AND MOUNTING DIMENSIONS

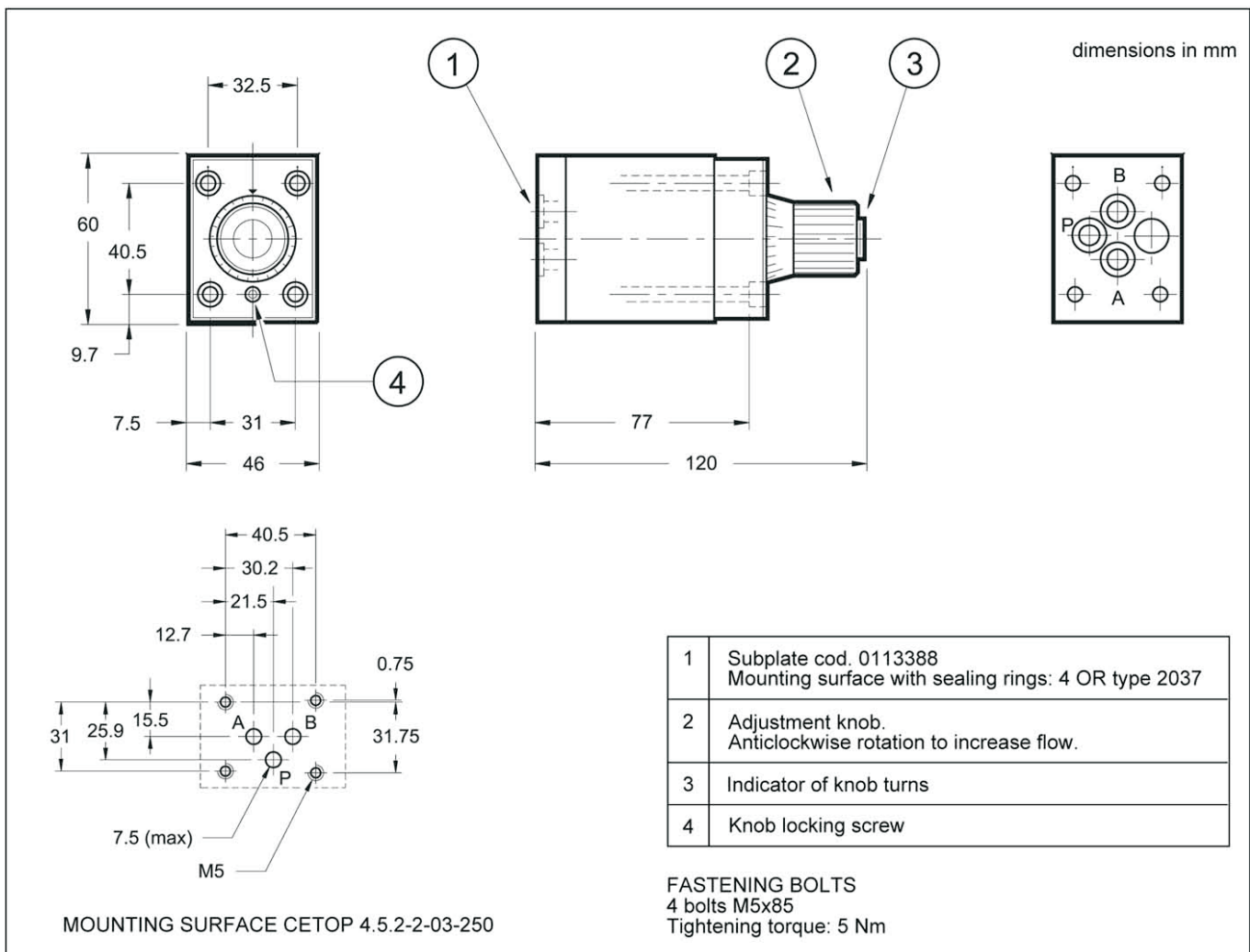

10 - SUBPLATES (see S.T. 51 000)

Type	PMRPC1-AI3G with rear ports PMRPC1-AL3G with side ports	
Type	PMMD-AI3G with rear ports, with user T plugged PMMD-AL3G with side ports, with user T plugged	only for valve RPC1-*/CTX
Port dimension	3/8" BSP	

11 - APPLICATION EXAMPLES

