

Part number:

096-10297

HYDROMA

HYDRAULICKÉ SYSTÉMY

**HIDROMA
SYSTEMS**

UKŁADY HYDRAULICZNE

HYDROMA

ГИДРАВЛИЧЕСКИЕ СИСТЕМЫ



RQ*-P

PRESSURE RELIEF VALVES

SERIES 40

SUBPLATE MOUNTING:

RQ3-P CETOP R06

RQ5-P CETOP R08

RQ7-P CETOP R10

HYDRAULIC SYMBOL

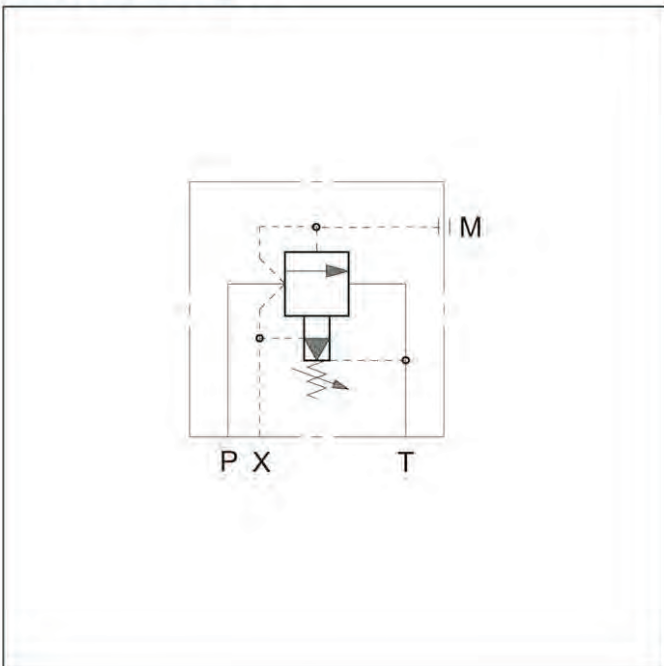

OPERATING PRINCIPLE

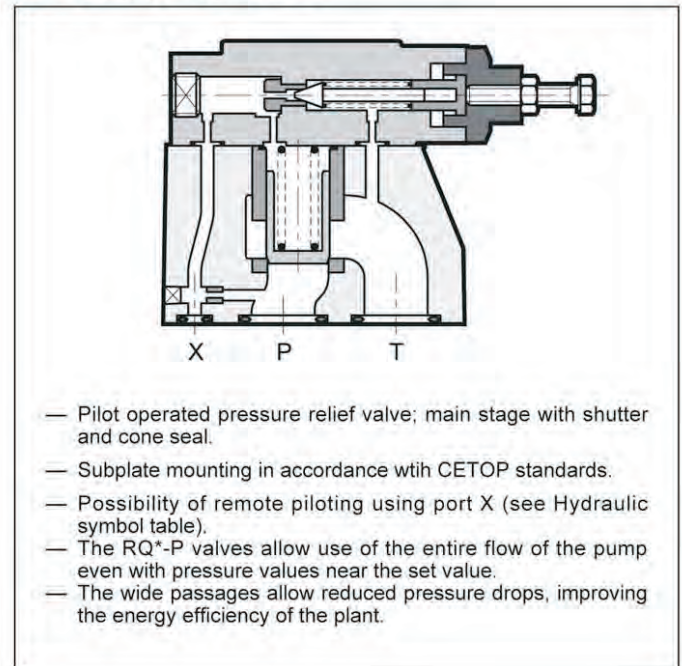

PERFORMANCE RATINGS (measured with mineral oil of viscosity 36 cSt at 50°C)		RQ3-P	RQ5-P	RQ7-P
Maximum operating pressure	bar	350		
Maximum flow rate	l/min	125	250	350
Ambient temperature range	°C	-20 ÷ +50		
Fluid temperature range	°C	-20 ÷ +70		
Fluid viscosity range	cSt	2,8 ÷ 380		
Recommended filtration	µm absolute	≤ 25		
Recommended viscosity	cSt	25		
Mass	kg	3,5	4,3	6,5

1 - IDENTIFICATION CODE

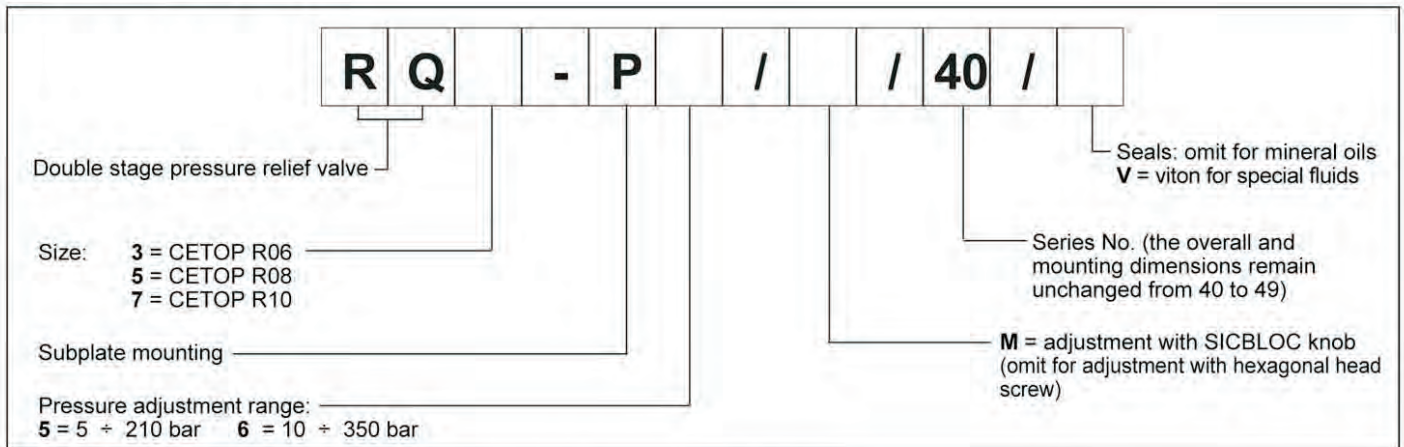

2 - CHARACTERISTIC CURVES (values obtained with viscosity of 36 cSt at 50°C)

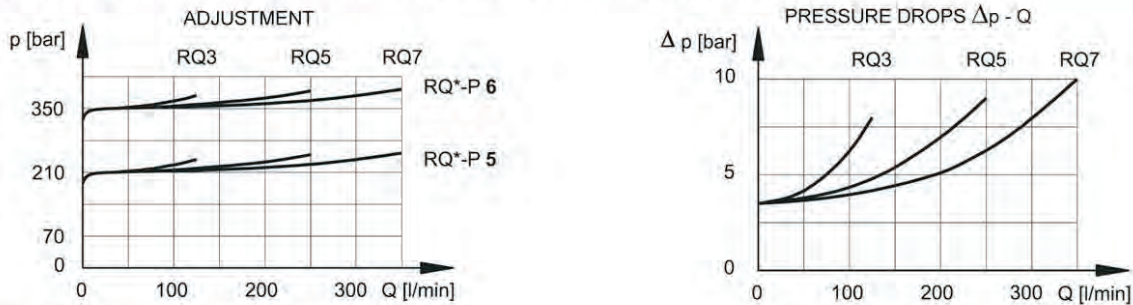

3 - HYDRAULIC FLUIDS

Use mineral oil-based hydraulic fluids, with the addition of suitable anti-frothing and anti-oxidizing agents. For the use of other types (water glycol, phosphate esters and others), please consult our technical department.

4 - RQ3-P OVERALL AND MOUNTING DIMENSIONS

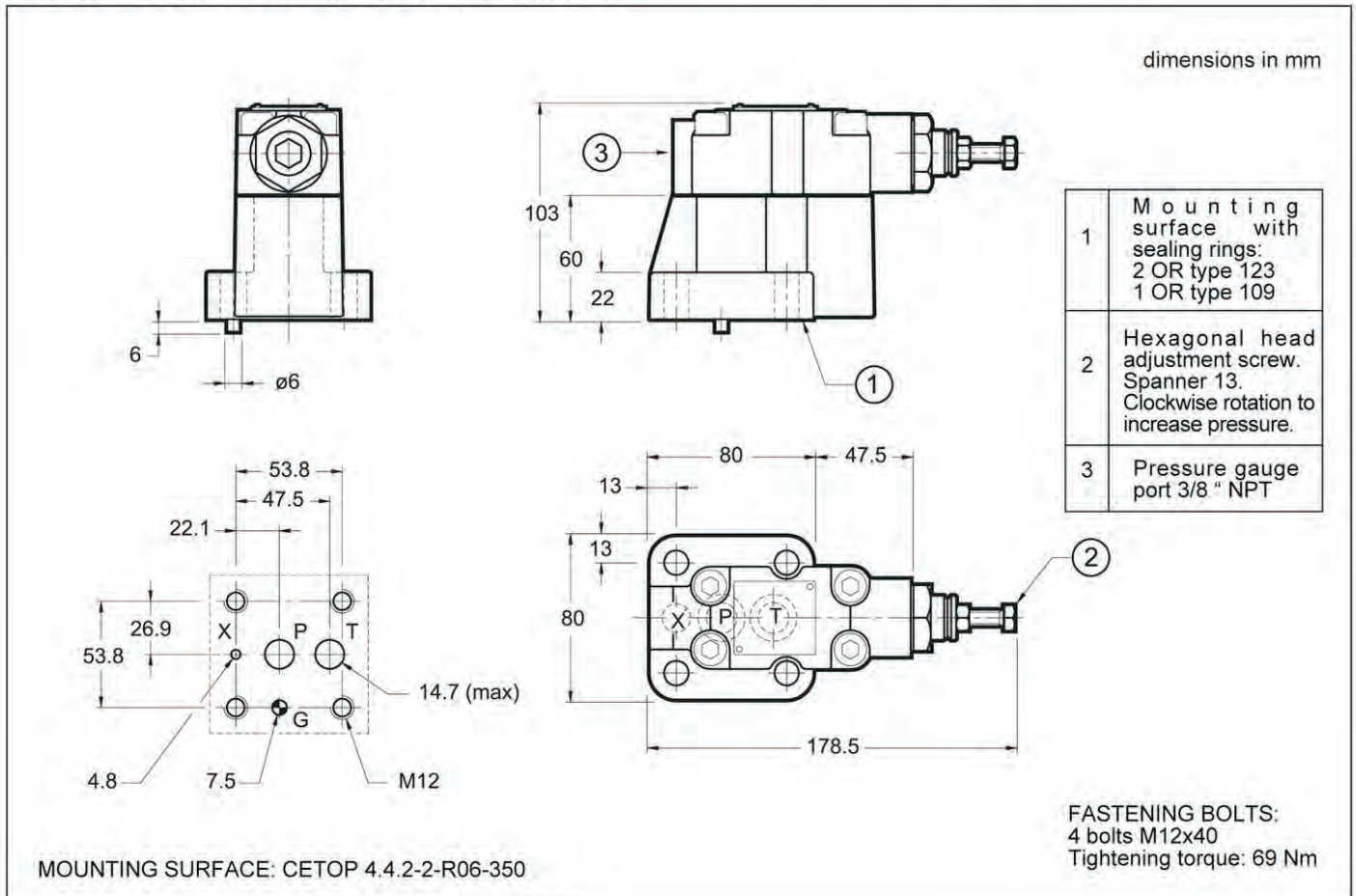

5 - RQ5-P OVERALL AND MOUNTING DIMENSIONS

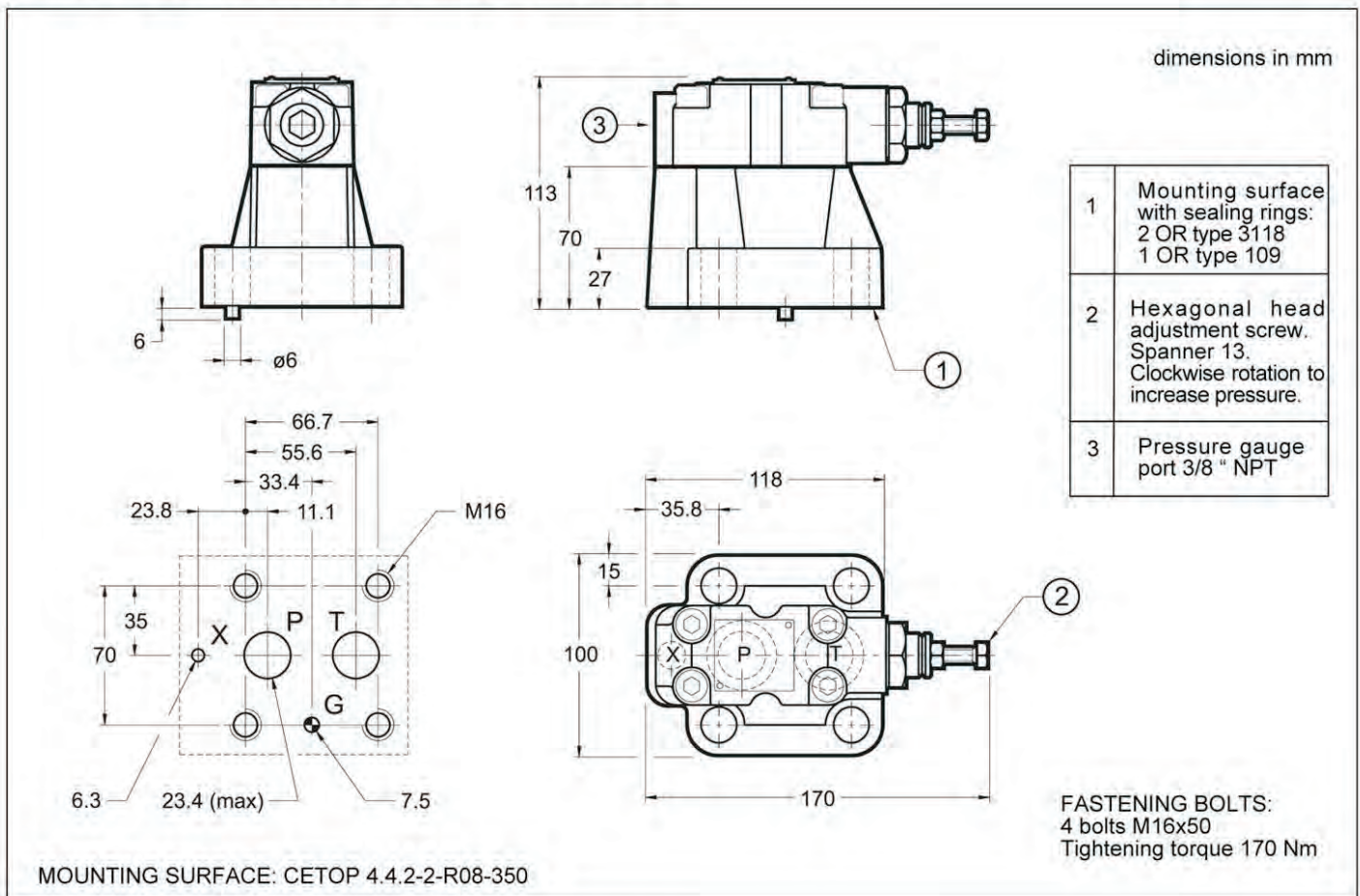

6 - RQ7-P OVERALL AND MOUNTING DIMENSIONS

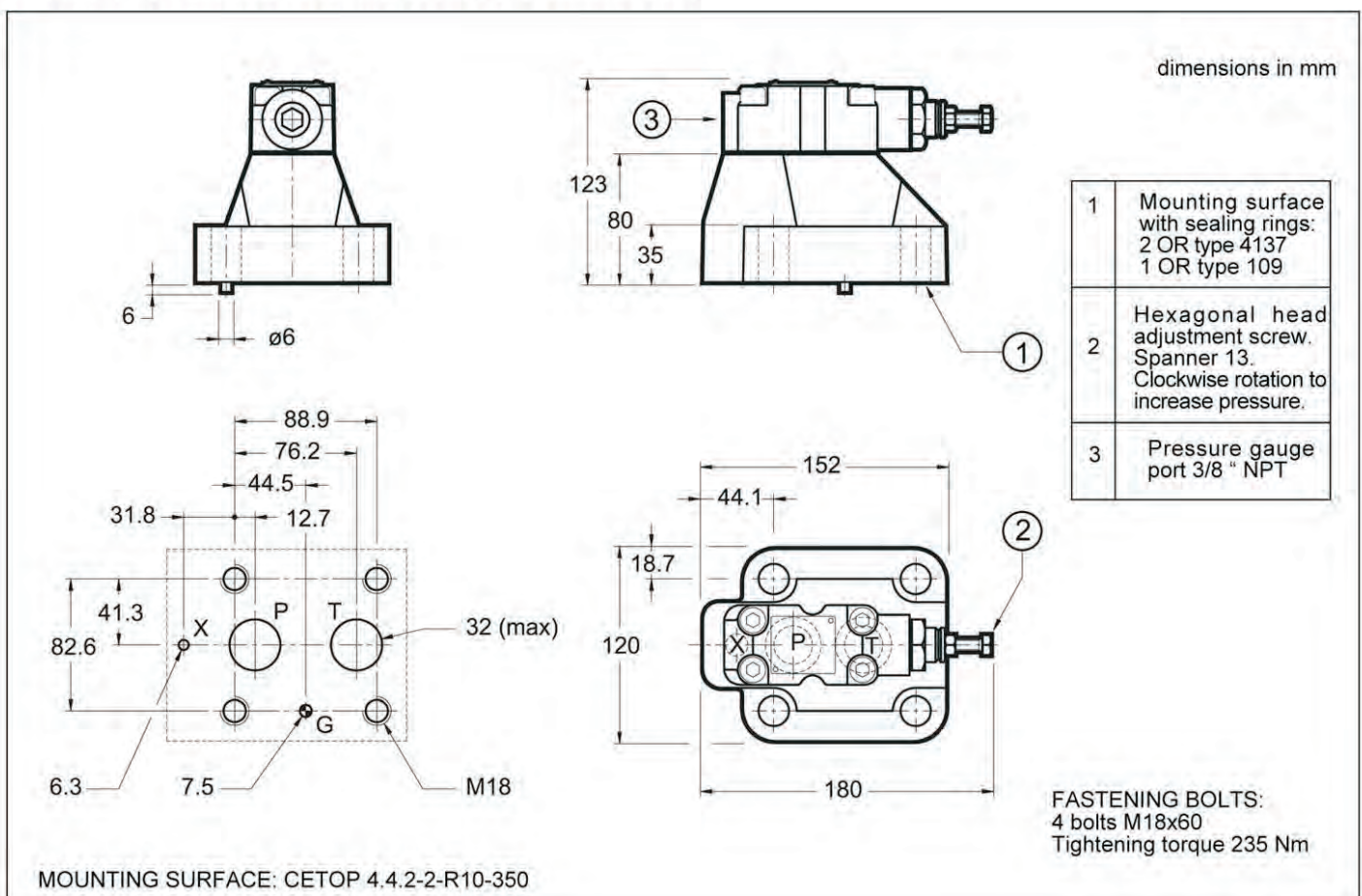

RQ*-P

SERIES 40

7 - ADJUSTMENT KNOB

The RQ valves can be equipped with a SICBLOC adjustment knob.
To operate it, push and rotate at the same time.
To request this option, add: /M (see par.1).

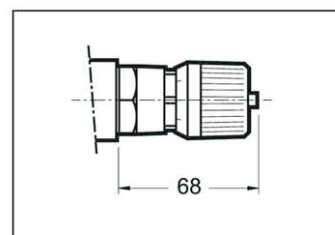

8 - SUBPLATES (see catalogue 51 000)

	RQ3-P	RQ5-P	RQ7-P
Type	PMRQ3-AI4G with rear ports	PMRQ5-AI5G with rear ports	PMRQ7-AI7G with rear ports
Port dimension PT	1/2" BSP	3/4" BSP	1" 1/4 BSP
Port dimension X	1/4" BSP	1/4" BSP	1/4" BSP