

Part number:

HYDROMA
HYDRAULICKÉ SYSTÉMY

HIDROMA
SISTEMS
UKŁADY HYDRAULICZNE

HYDROMA
ГИДРАВЛИЧЕСКИЕ СИСТЕМЫ

FPA-MDM

PRESSURE FILTERS

MATERIALS

Housing: Anodized aluminium alloy

Bypass valve: Brass

Seals: NBR Nitrile (FKM Fluoroelastomer - on request)

Indicator housing: Brass

PRESSURE

Max working: 11 MPa (110 bar)

Collapse, differential for the filter element (ISO 2941):
8 MPa (80 bar)

BYPASS VALVE

Setting: 600 kPa (6 bar) \pm 10%

WORKING TEMPERATURE

From -25° to +110° C

COMPATIBILITY (ISO 2943)

Full with fluids: HH-HL-HM-HV-HTG
(according to ISO 6743/4)

For fluids different than the above mentioned,
please contact our Customer Service.

HYDRAULIC DIAGRAM

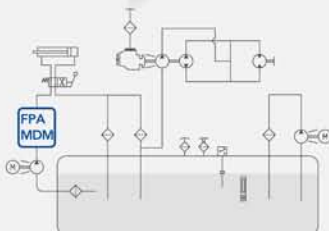

FPA

PRESSURE FILTERS

ORDERING AND OPTION CHART

F	P	A	COMPLETE FILTER FAMILY			FILTER ELEMENT FAMILY	E	P	A
			SIZE & LENGTH	11	12	SIZE & LENGTH			
			PORT TYPE						
			B = BSP thread	B	B				
			N = NPT thread *	N	N				
			S = SAE thread *	S	S				
			PORT SIZE						
			04 = 1/2" (N04 not available)	04	04				
			BYPASS VALVE						
			W = without	W	W				
			C = 600 kPa (6 bar)	C	C				
			SEALS			SEALS			
			N = NBR Nitrile	N	N				
			F = FKM Fluoroelastomer	F	F				
			FILTER MEDIA			FILTER MEDIA			
			FA = fibreglass 5 µm(c) β>1.000	FA	FA				
			FB = fibreglass 7 µm(c) β>1.000	FB	FB				
			FC = fibreglass 12 µm(c) β>1.000	FC	FC				
			FS = fibreglass 16 µm(c) β>1.000	FS	FS				
			FD = fibreglass 21 µm(c) β>1.000	FD	FD				
			FE = fibreglass 30 µm(c) β>1.000	FE	FE				
			CLOGGING INDICATOR**						
			03 = port, plugged	03	03				
			5E = visual differential 500 kPa (5 bar)	5E	5E				
			6E = electrical differential 500 kPa (5 bar)	6E	6E				
			7E = indicator 6E with LED	7E	7E				
			T2 = elect. diff. 500 kPa (5 bar) with thermostat 30°C	T2	T2				
X	X		ACCESSORIES						
			XX = no accessory available	XX	XX				

SPARE PARTS ELEMENTS

FILTER HOUSING	FILTER ELEMENT	CLOGGING INDICATOR
		
B P A 0 4 X X	E P A	

MDM

PRESSURE FILTERS

ORDERING AND OPTION CHART

M	D	M	COMPLETE FILTER FAMILY			FILTER ELEMENT FAMILY	C	D	M
			SIZE & LENGTH	101	102	SIZE & LENGTH			
			FILTER MEDIA			FILTER MEDIA			
			FT = fibreglass 5 µm(c) β>1.000	FT	FT				
			FC = fibreglass 7 µm(c) β>1.000	FC	FC				
			FD = fibreglass 12 µm(c) β>1.000	FD	FD				
			FS = fibreglass 16 µm(c) β>1.000	FS	FS				
			FV = fibreglass 21 µm(c) β>1.000	FV	FV				
			SEALS			SEALS			
			1 = NBR Nitrile	1	1				
			2 = FKM Fluoroelastomer	2	2				
			BYPASS VALVE						
			S = without	S	S				
			C = 600 kPa (6 bar)	C	C				
			PORT TYPE						
			B = BSP thread	B	B				
			N = NPT thread *	N	N				
			S = SAE thread *	S	S				
			PORT SIZE						
			3 = 1/2" (N3 not available)	3	3				
			CLOGGING INDICATOR **						
			03 = port, plugged	03	03				
			5E = visual differential 500 kPa (5 bar)	5E	5E				
			6E = electrical differential 500 kPa (5 bar)	6E	6E				
			7E = indicator 6E with LED	7E	7E				
			T2 = elect. diff. 500 kPa (5 bar) with thermostat 30°C	T2	T2				
X	X		ACCESSORIES						
			XX = no accessory available	XX	XX				

SPARE SEAL KIT

	NBR	FKM
FPA11 MDM101	521.0001.2	521.0062.2
FPA12 MDM102	521.0001.2	521.0062.2

* Not standard version, please check availability with our Customer Service

** When the filter is ordered with FKM seals, the first digit of the indicator code is a letter (please see Clogging Indicator Chapter for further details)

FPA-MDM

PRESSURE FILTERS

INSTALLATION DRAWING

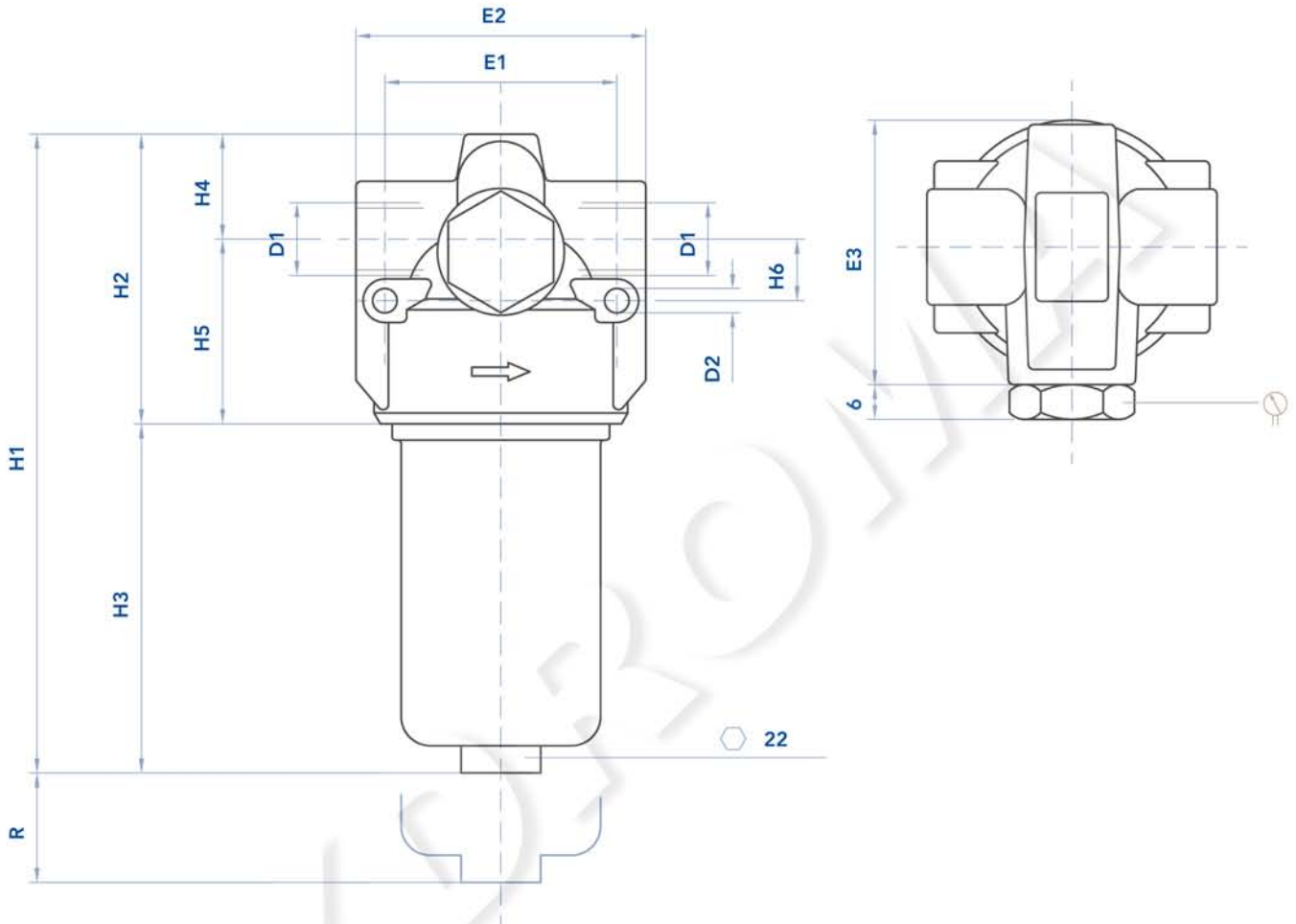

FILTER HOUSING

	D1	D2	H1	H2	H3	H4	H5	H6	E1	E2	E3	R	Kg
FPA11 MDM101	1/2"	6,5	157	78	79	28	50	17	64	76	75	60	0,65
FPA12 MDM102	1/2"	6,5	244	78	166	28	50	17	64	76	75	60	0,85

MAINTENANCE

The best time to change your filter element is just before it reaches its maximum dirt-holding capacity. For this reason, we recommend to monitor the pressure of the hydraulic oil flowing through the filter with a clogging indicator. When it is time to change the filter element, switch off the system before opening the filter housing and make sure there is no pressure in the filter. Unscrew the bowl and remove the dirty filter element. Replace it with an original UFI element, verifying the part number on the filter label or on the catalogue. Clean the bowl;

check the gaskets conditions and replace if necessary. Insert the clean element into his seat, handling with care and cleanliness. Screw the housing until it stops, with a tightening torque of 50 Nm +5/0. We recommend the stocking of a spare UFI filter element for timely replacement when required.

N.B. The used filter elements cannot be cleaned and are classified as "Dangerous waste material": they must be disposed according to the local laws by authorized Companies.



FILTER ELEMENT

	A	B	C	Kg	AREA (cm ²) Media F+
EPA11 CDM101	22	42	91	0,15	295
EPA12 CDM102	22	42	179	0,25	600

The used filter elements cannot be cleaned and are classified as "Dangerous waste material". They must be disposed according to local laws by authorized Companies.

Verify that the Company you choose has the expertise and authorization to dispose this type of waste material.

FPA-MDM

PRESSURE FILTERS

PRESSURE DROP CURVES (ΔP)

The "Assembly Pressure Drop (Δp)" is obtained by adding the pressure drop values of the Filter Housing and of the Clean Filter Element corresponding to the considered Flow Rate and it must

be lower than 80 kPa (0,8 bar) and should never exceed 1/3 of the bypass valve setting.

BYPASS VALVE PRESSURE DROP

When selecting the filter size, these curves must be taken into account if it is foreseen that any flow peak is to be absorbed by the bypass valve, it also must be of proper configuration to avoid pressure peaks. The valve pressure drop is directly proportional to fluid specific gravity.

FILTER HOUSING PRESSURE DROP
(mainly depending on the port size)

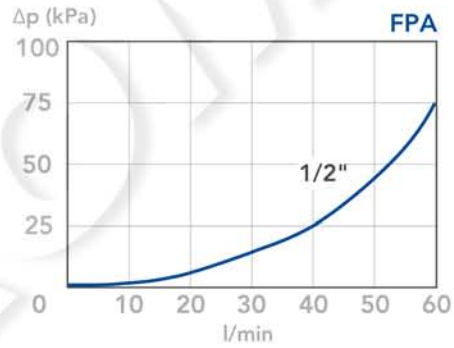
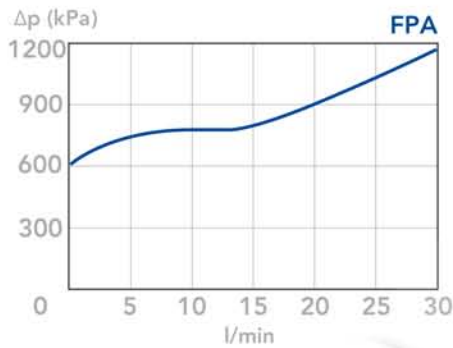

CLEAN FILTER ELEMENT PRESSURE DROP WITH F+ MEDIA
(depending both on the internal diameter of the element and on the filter media)

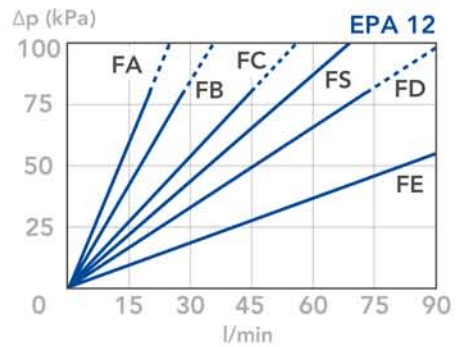
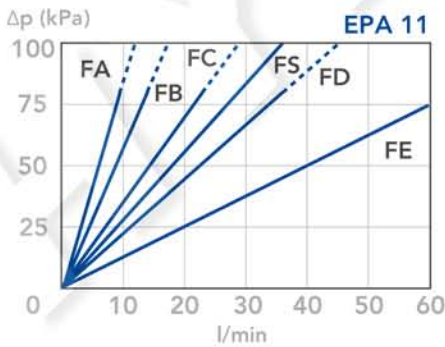

N.B.

All the curves have been obtained with mineral oil having a kinematic viscosity 30 cSt and specific gravity 0,86 Kg/dm³; for fluids with different features, please consider the factors described in the first part of this catalogue. All the curves

are obtained from test done at the UFI HYDRAULIC DIVISION Laboratory, according to the specification ISO 3968. In case of discrepancy, please check the contamination level, viscosity and features of the fluid in use.