

Part number:

**074-10666**

**HYDROMA**

HYDRAULICKÉ SYSTÉMY

**HIDROMA  
SYSTEMS**

UKŁADY HYDRAULICZNE

**HYDROMA**

ГИДРАВЛИЧЕСКИЕ СИСТЕМЫ

• **Materials**

Body: Carbon Steel EN -10277-3

Seals: NBR, Viton or EPDM

Back-Up-Ring: PTFE

Balls: AISI 1010/1015

Springs: Carbon Steel

DIN 17233/84(B)

• **Working temperature (Seals)**

	NBR	Viton	EPDM
	+100°C	+200°C	+150°C
	-30°C	-10°C	-40°C

• **Applications:** Designed for Oil hydraulic Applications according to European Directive 97.23.EC

• **Sectors:** Industrial, Agricultural



• **Equivalence**

FASTER ANV

AEROQUIP FD56

PARKER 6600

SNAP-TITE 61

**MODEL STRUCTURE**

Example;

**102.11112 JE**

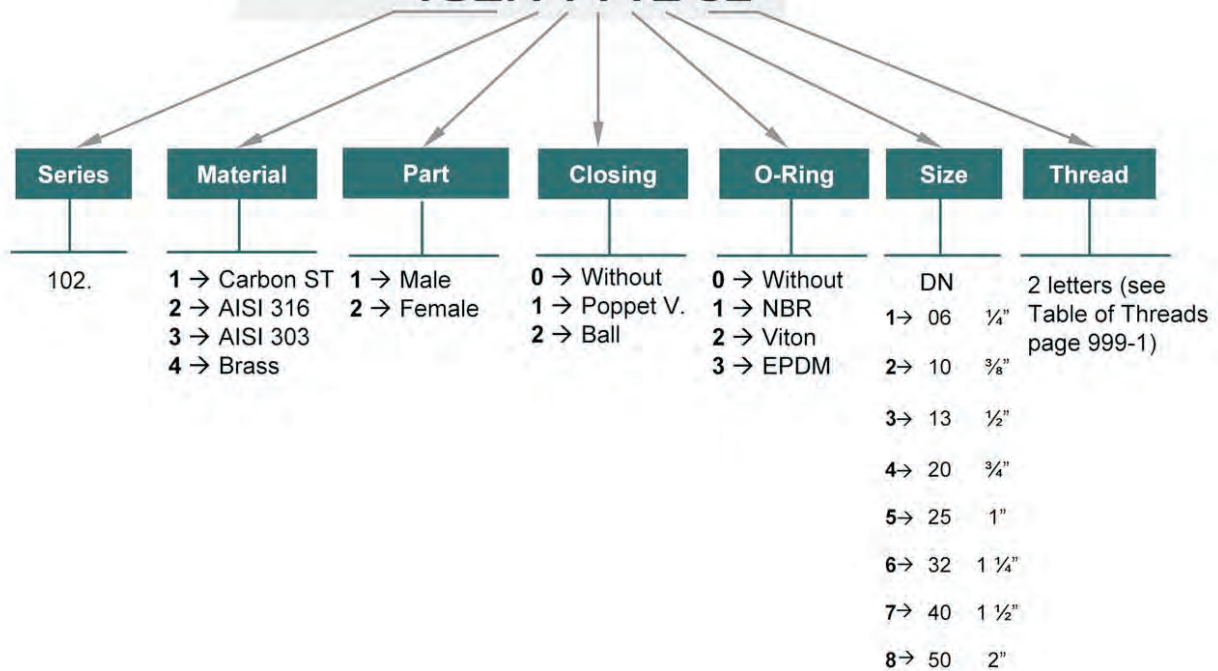

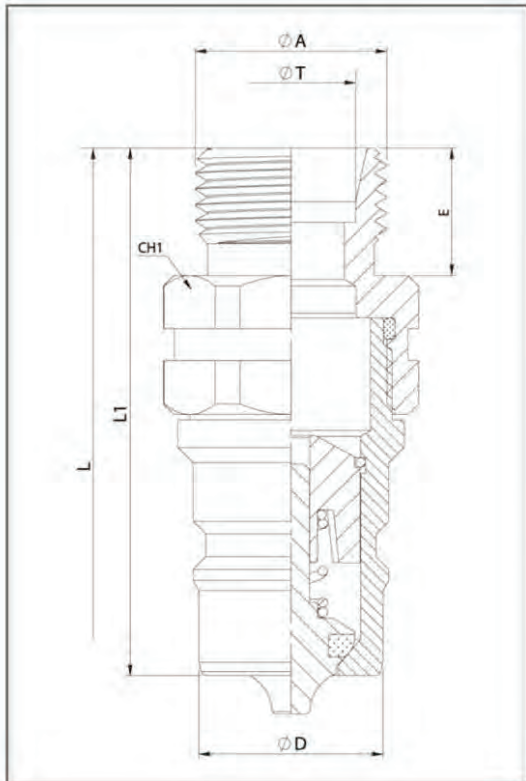

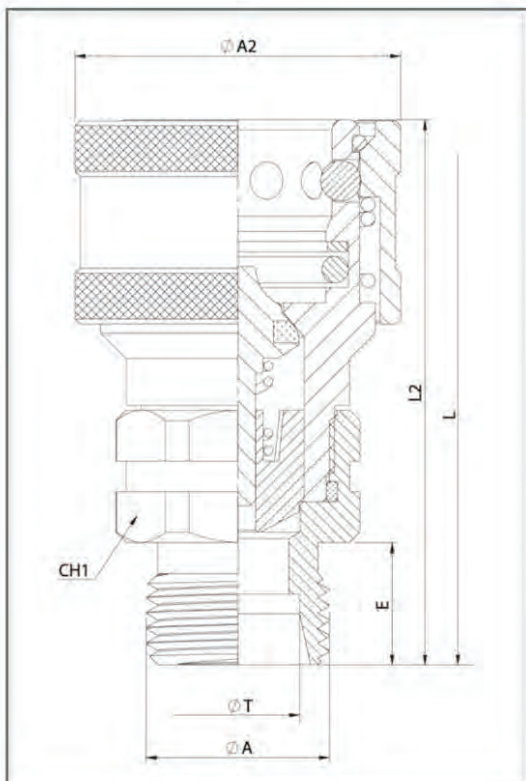

STANDARD MALE MODELS														
DN	ØA	ØT	REF.		CH1	L1	ØD	E	L					
06	M12x1,5	6L	102.11111JB	350Bar	19	*	11,8	12	*					
	M14x1,5	8L	102.11111JC											
	M18x1,5	12L	102.11112JE											
10	M14x1,5	8L	102.11112JC	300Bar	22	*	17,25	12	*					
	M16x1,5	10L	102.11112JD											
	M18x1,5	12L	102.11112JE											
13	M14x1,5	8L	102.11113JC	300Bar	27	*	20,56	12	*					
	M16x1,5	10L	102.11113JD											
	M18x1,5	12L	102.11113JE											
	M22x1,5	15L	102.11113JG											
	M26x1,5	18L	102.11113JI											
20	M18x1,5	12L	102.11114JE	250Bar	36	*	29	12	*					
	M22x1,5	15L	102.11114JG					18						
	M26x1,5	18L	102.11114JI					12						
	M30x2	22L	102.11114JJ					18						
	M26x1,5	18L	102.11115JI					12						
25	M30x2	22L	102.11115JJ	230Bar	41	*	34,3	18	*					
	M36x2	28L	102.11115JK					16						
	M45x2	35L	102.11115JM					16						
	M16x1,5	8S	102.11112KD					300Bar		22	*	17,25	12	*
	M18x1,5	10S	102.11112KE											
M20x1,5	12S	102.11112KF												
M18x1,5	10S	102.11113KE												
M20x1,5	12S	102.11113KF												
13	M22x1,5	14S	102.11113KG	300Bar	27	*	20,56	12	*					
	M24x1,5	16S	102.11113KH											
	M24x1,5	16S	102.11114KH											
20	M30x2	20S	102.11114KJ	250Bar	36	*	29	12	*					
	M30x2	20S	102.11115KJ					16						
	M36x2	25S	102.11115KK					18						
25	M42x2	30S	102.11115KL	230Bar	41	*	34,3	18	*					
	M42x2	30S	102.11115KL					46						
	M52x2	38S	102.11115KN					55		20				

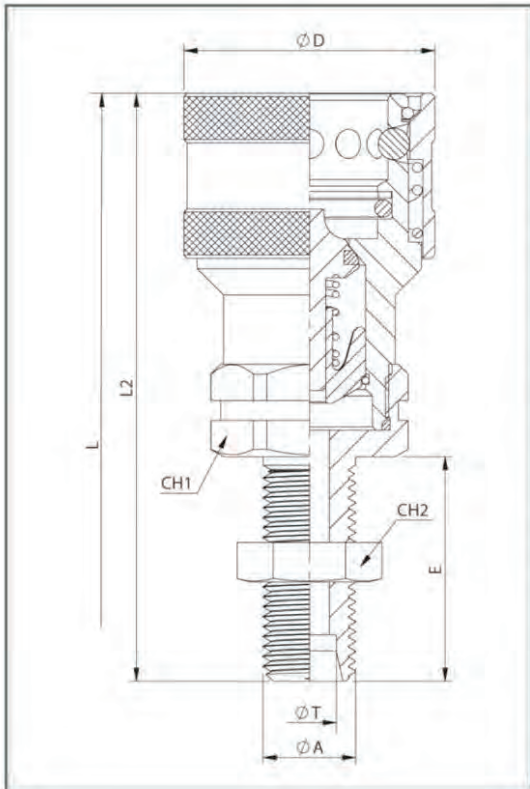
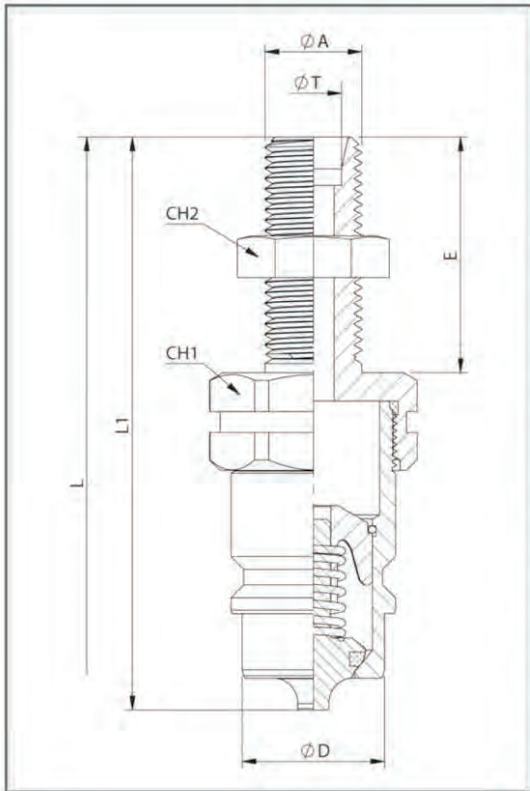

STANDARD FEMALE MODELS														
DN	ØA	ØT	REF.		CH1	L2	ØA2	E	L					
06	M12x1,5	6L	102.12111JB	350Bar	19	*	26	12	*					
	M14x1,5	8L	102.12111JC											
	M18x1,5	12L	102.12112JE											
10	M14x1,5	8L	102.12112JC	300Bar	22	*	32	12	*					
	M16x1,5	10L	102.12112JD											
	M18x1,5	12L	102.12112JE											
13	M14x1,5	8L	102.12113JC	300Bar	27	*	38	12	*					
	M16x1,5	10L	102.12113JD											
	M18x1,5	12L	102.12113JE											
	M22x1,5	15L	102.12113JG											
	M26x1,5	18L	102.12113JI											
20	M18x1,5	12L	102.12114JE	250Bar	36	*	46	12	*					
	M22x1,5	15L	102.12114JG					18						
	M26x1,5	18L	102.12114JI					12						
	M30x2	22L	102.12114JJ					18						
	M26x1,5	18L	102.12115JI					12						
25	M30x2	22L	102.12115JJ	230Bar	41	*	55	18	*					
	M36x2	28L	102.12115JK					16						
	M45x2	35L	102.12115JM					16						
	M16x1,5	8S	102.12112KD					300Bar		22	*	32	12	*
	M18x1,5	10S	102.12112KE											
M20x1,5	12S	102.12112KF												
M18x1,5	10S	102.12113KE												
M20x1,5	12S	102.12113KF												
13	M22x1,5	14S	102.12113KG	300Bar	27	*	38	12	*					
	M24x1,5	16S	102.12113KH											
	M24x1,5	16S	102.12114KH											
20	M30x2	20S	102.12114KJ	250Bar	36	*	46	12	*					
	M30x2	20S	102.12115KJ					16						
	M36x2	25S	102.12115KK					18						
25	M42x2	30S	102.12115KL	230Bar	41	*	55	18	*					
	M42x2	30S	102.12115KL					46						
	M52x2	38S	102.12115KN					55		20				



### STANDARD MALE MODELS

DN	$\varnothing A$	$\varnothing T$	REF.		CH1	CH2	L1	$\varnothing D$	E	L	Light Series	
06	M12x1,5	6L	102.11111LB	350Bar	19	19	*	11,8	25	*		
	M14x1,5	8L	102.11111LC						34			
	M14x1,5	8L	102.11112LC						34			
10	M16x1,5	10L	102.11112LD	300Bar	22	22	*	17,25	26	*		
	M18x1,5	12L	102.11112LE						27			
	M14x1,5	8L	102.11113LC						19		34	
13	M16x1,5	10L	102.11113LD	300Bar	27	24	*	20,56	35	*		
	M18x1,5	12L	102.11113LE						27		35	
	M22x1,5	15L	102.11113LG						27		33	
	M26x1,5	18L	102.11113LI						30		33	
20	M18x1,5	12L	102.11114LE	250Bar	36	27	*	29	26	*		
	M22x1,5	15L	102.11114LG						27		33	
	M26x1,5	18L	102.11114LI						30		34	
	M30x2	22L	102.11114LJ						36		34	
25	M30x2	22L	102.11115LJ	230Bar	41	36	*	34,3	36	*		
	M36x2	28L	102.11115LK						41		34	
	M45x2	35L	102.11115LM						55		36	
	M16x1,5	8S	102.11112MD						300Bar		22	22
M18x1,5	10S	102.11112ME	24	27								
M20x1,5	12S	102.11112MF	22	27								
13	M18x1,5	10S	102.11113ME	300Bar	27	22	*	20,56	24	*		
	M20x1,5	12S	102.11113MF						22		35	
	M22x1,5	14S	102.11113MG						27		35	
	M24x1,5	16S	102.11113MH						30		35	
20	M24x1,5	16S	102.11114MH	250Bar	36	30	*	29	29	*		
	M30x2	20S	102.11114MJ						36		36	
	M30x2	20S	102.11115MJ						36		36	
	M36x2	25S	102.11115MK						41		38	
25	M42x2	30S	102.11115ML	230Bar	41	50	*	34,3	40	*		
	M42x2	30S	102.11115ML						50		40	
	M52x2	38S	102.11115MN						65		40	

### STANDARD FEMALE MODELS

DN	$\varnothing A$	$\varnothing T$	REF.		CH1	CH2	L2	$\varnothing D$	E	L	Light Series	
06	M12x1,5	6L	102.12111LB	350Bar	19	19	*	11,8	25	*		
	M14x1,5	8L	102.12111LC						34			
	M14x1,5	8L	102.12112LC						34			
10	M16x1,5	10L	102.12112LD	300Bar	22	22	*	17,25	26	*		
	M18x1,5	12L	102.12112LE						27			
	M14x1,5	8L	102.12113LC						19		34	
13	M16x1,5	10L	102.12113LD	300Bar	27	24	*	20,56	35	*		
	M18x1,5	12L	102.12113LE						27		35	
	M22x1,5	15L	102.12113LG						27		33	
	M26x1,5	18L	102.12113LI						30		33	
20	M18x1,5	12L	102.12114LE	250Bar	36	27	*	29	26	*		
	M22x1,5	15L	102.12114LG						27		33	
	M26x1,5	18L	102.12114LI						30		34	
	M30x2	22L	102.12114LJ						36		34	
25	M30x2	22L	102.12115LJ	230Bar	41	36	*	34,3	36	*		
	M36x2	28L	102.12115LK						41		34	
	M45x2	35L	102.12115LM						55		36	
	M16x1,5	8S	102.12112MD						300Bar		22	22
M18x1,5	10S	102.12112ME	24	27								
M20x1,5	12S	102.12112MF	22	27								
13	M18x1,5	10S	102.12113ME	300Bar	27	22	*	20,56	24	*		
	M20x1,5	12S	102.12113MF						22		35	
	M22x1,5	14S	102.12113MG						27		35	
	M24x1,5	16S	102.12113MH						30		35	
20	M24x1,5	16S	102.12114MH	250Bar	36	30	*	29	29	*		
	M30x2	20S	102.12114MJ						36		36	
	M30x2	20S	102.12115MJ						36		36	
	M36x2	25S	102.12115MK						41		38	
25	M42x2	30S	102.12115ML	230Bar	41	50	*	34,3	40	*		
	M42x2	30S	102.12115ML						50		40	
	M52x2	38S	102.12115MN						65		40	

Light Series

Heavy Series

Light Series

Heavy Series

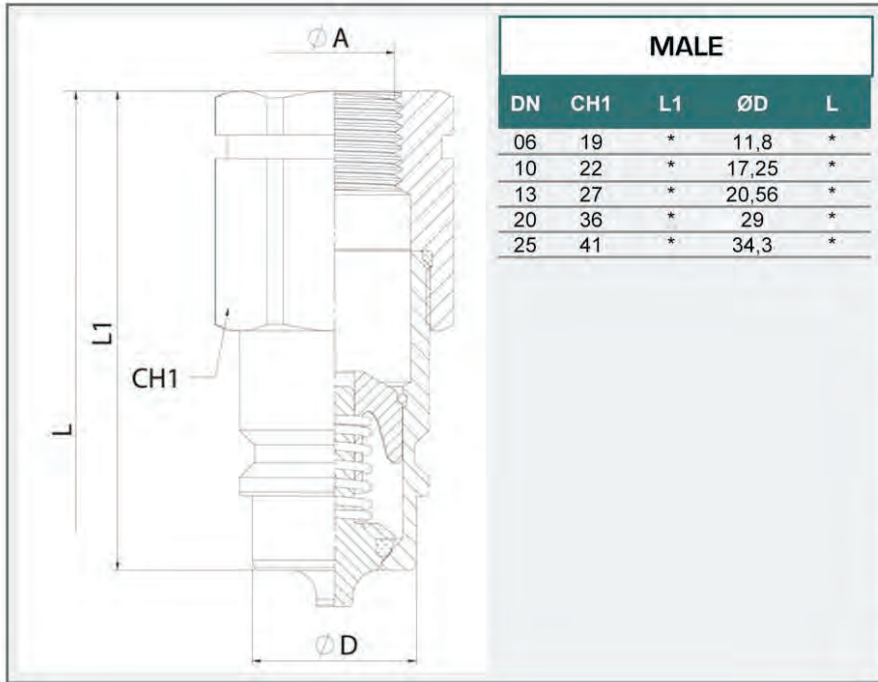

MALE				
DN	CH1	L1	ØD	L
06	19	*	11,8	*
10	22	*	17,25	*
13	27	*	20,56	*
20	36	*	29	*
25	41	*	34,3	*

STANDARD MODELS				
DN	ØA	MALE	FEMALE	
06	1/4" BSP	102.11111AB	102.12111AB	350Bar
	1/4" NPTF	102.11111BB	102.12111BB	
	M14x1,5	102.11111NC	102.12111NC	
10	1/4" BSP	102.11112AB	102.12112AB	300Bar
	3/8" BSP	102.11112AC	102.12112AC	
	3/8" NPTF	102.11112BC	102.12112BC	
13	M16x1,5	102.11112ND	102.12112ND	300Bar
	3/8" BSP	102.11113AC	102.12113AC	
	1/2" BSP	102.11113AD	102.12113AD	
13	1/2" NPTF	102.11113BD	102.12113BD	300Bar
	M18x1,5	102.11113NE	102.12113NE	
	M22x1,5	102.11113NG	102.12113NG	
20	3/4" -16ORB	102.11113GF	102.12113GF	230Bar
	3/8" -14ORB	102.11113GH	102.12113GH	
	3/4" BSP	102.11114AE	102.12114AE	
20	3/4" NPTF	102.11114BE	102.12114BE	230Bar
	M22x1,5	102.11114NG	102.12114NG	
25	3/4" BSP	102.11115AE	102.12115AE	230Bar
	1" BSP	102.11115AF	102.12115AF	
	1" NPTF	102.11115BF	102.12115BF	

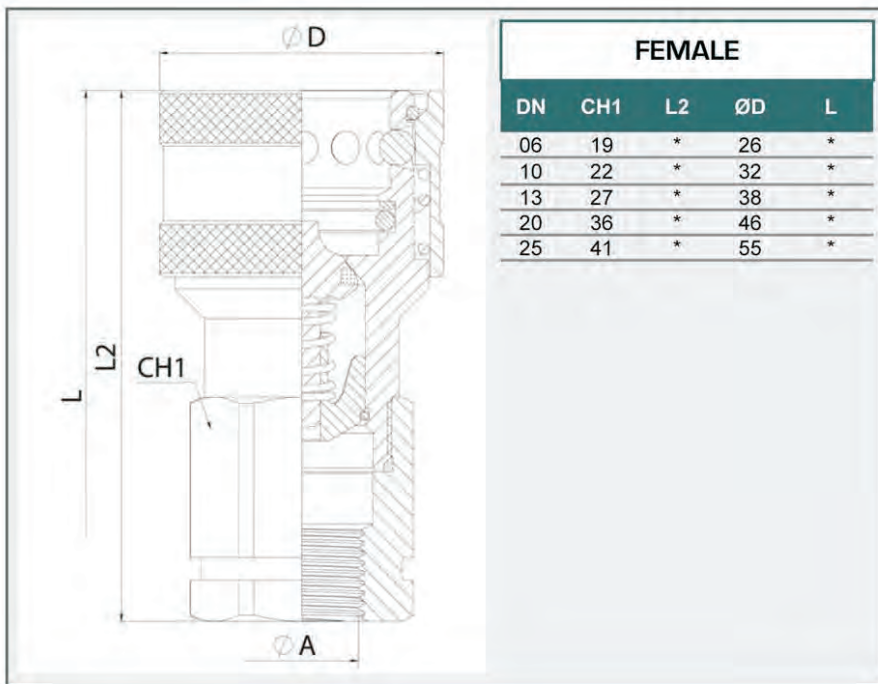

FEMALE				
DN	CH1	L2	ØD	L
06	19	*	26	*
10	22	*	32	*
13	27	*	38	*
20	36	*	46	*
25	41	*	55	*