

Part number:



FPH

PRESSURE FILTER FOR LINE MOUNTING

SERIES 11

p max 420 bar
Q max (see table of performances)

OPERATING PRINCIPLE

- FPH filters are designed to be line-mounted with BSP threaded ports for hydraulic connections. Threaded holes are machined on the head for possible filter bracket fixing.
- The replacement of the filter element can be easily carried out by using a normal hexagon spanner to unscrew the bowl of the filter, which has a suitably shaped end.
- FPH filters are designed to be installed on pressure lines up to 420 bar; the filter elements are made of high efficiency filtering materials and are capable of holding high quantities of contamination particles. They are available with three different filtration degrees:
 - H05 = 5 µm: absolute ($\beta_{25} > 100$ - ISO 4406:1999 class 17/15/12) cartridge with a collapsing differential pressure = 210 bar to be used without a by-pass valve.
 - F10 = 10 µm: absolute ($\beta_{10} > 100$ - ISO 4406:1999 class 18/16/13)
 - F25 = 25 µm: absolute ($\beta_{25} > 100$ - ISO 4406:1999 class 19/17/14)
- Those filters with a F10 and F25 filtration degree are supplied with a by-pass valve and have a cartridge with a collapsing differential pressure = 20 bar.
- All the FPH filters are designed to incorporate a visual-differential or a visual-electric clogging indicator to be ordered separately (see par. 5).

PERFORMANCES

Filter code	BSP port dimensions	Mass [Kg]	Rated flow (indicative) [l/min]		
			H05	F10	F25
FPH-TB012	1/2"	4.4	10	27	33
FPH-TB034	3/4"	5.2	19	42	65
FPH-TB100	1"	8.2	40	95	105
FPH-TB114	1 1/4"	14	88	190	230
FPH-TB112	1 1/2"	17.2	120	260	320

NOTE 1: The flow rates stated in the table correspond to a 0.8 bar pressure drop measured with mineral oil of viscosity 36 cSt at 50°C.
As for a different viscosity range, see NOTE 2 - par. 2.2.

Maximum operating pressure	bar	420
Collapsing differential pressure of the filter element: H05	bar	210
F-10-F25	bar	20
Differential pressure for the opening of the by-pass valve ($\pm 10\%$)	bar	6
Ambient temperature range	°C	-25 / +50
Fluid temperature range	°C	-25 / +110
Fluid viscosity range	cSt	10 ÷ 400

HYDRAULIC SYMBOL

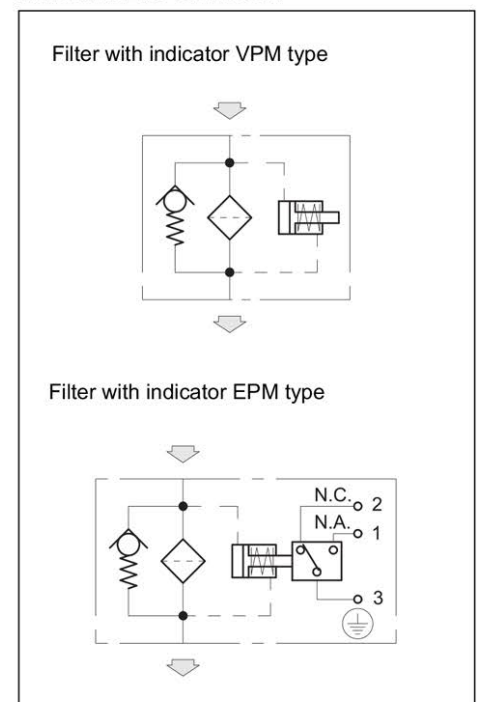

1 - IDENTIFICATION CODE

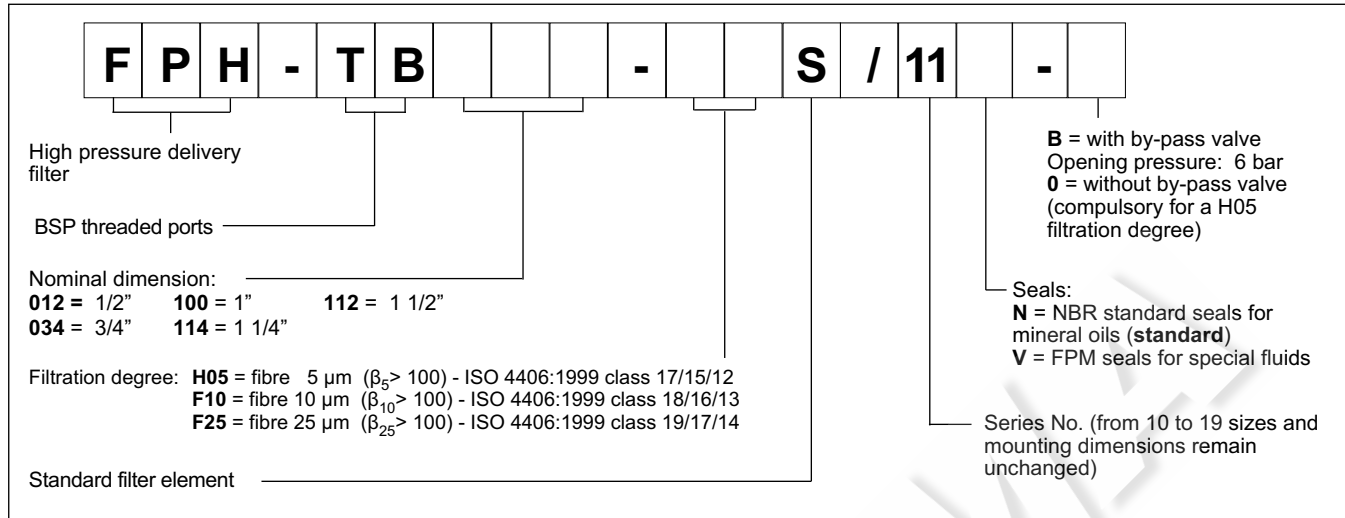

2 - CHARACTERISTIC CURVES (values measured with viscosity of 36 cSt at 50°C)

2.1 - Pressure drops through the filter body

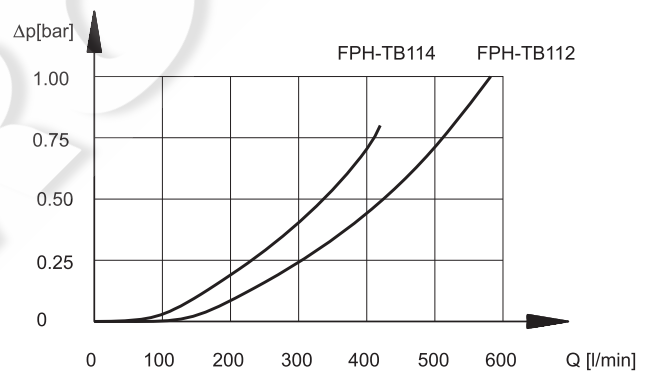
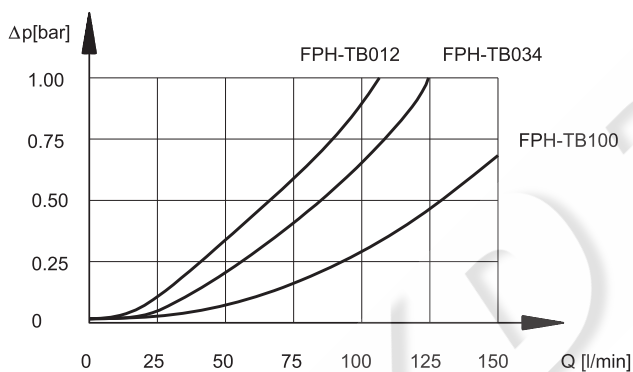

2.2 - Pressure drops through the FPHE filter element

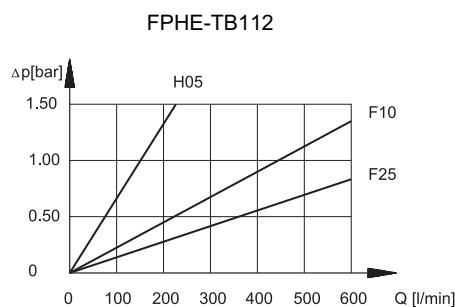
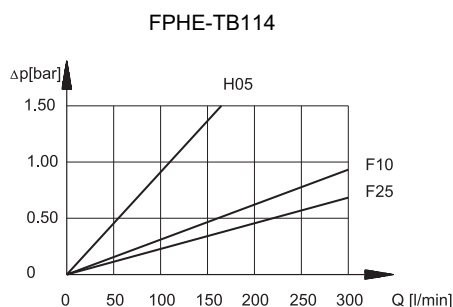
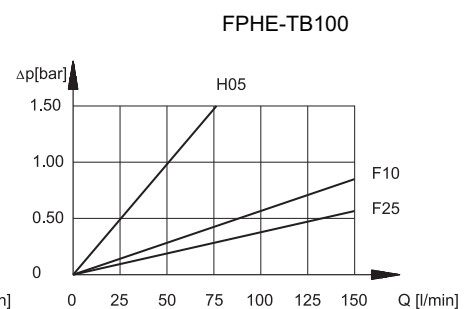
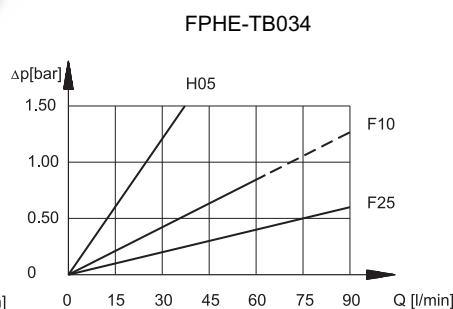
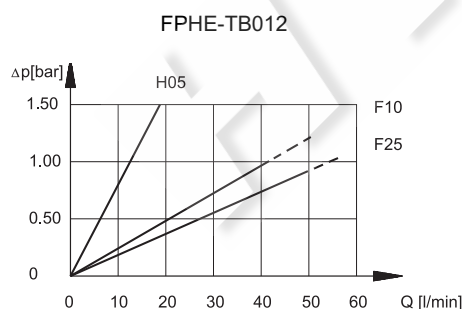

NOTE 2: The filter size has to be selected so that with the nominal flow rate the pressure drop is lower than 0.8 bar.

The total pressure drop through the filter is given by adding the body pressure drop values to those of the filter element. As for fluids whose viscosity degree at a specific operating pressure is different from 36 cSt, the filter total pressure drop has to be changed according to the following ratio:

$$\text{total } \Delta p_l \text{ value} = \text{body } \Delta p \text{ value} + (\text{real } \Delta p \text{ value of the filter element} \times \text{real viscosity value (cSt)} / 36)$$

$$\text{real } \Delta p \text{ value of the filter element} = \text{value obtainable through the diagrams in par. 2.2}$$

Such ratio is valid for a viscosity value up to 200 cSt. For a higher viscosity please consult our technical department.

2.3 - Pressure drops through the by-pass valve

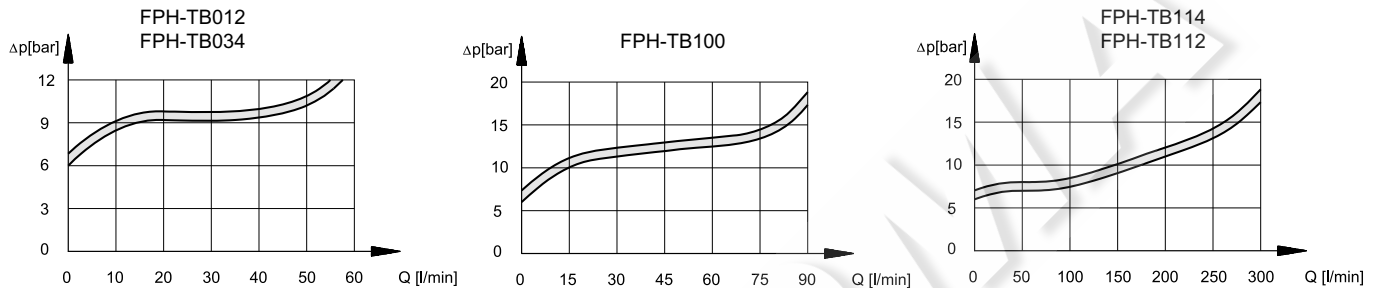

3 - HYDRAULIC FLUIDS

Use mineral oil-based hydraulic fluids HL or HM type, according to ISO 6743-4. For these fluids, use NBR seals. For fluids HFDR type (phosphate esters) use FPM seals (code V). For the use of other kinds of fluid such as HFA, HFB, HFC, please consult our technical department. Using fluids at temperatures higher than 80 °C causes a faster degradation of the fluid and of the seals characteristics.

The fluid must be preserved in its physical and chemical characteristics.

4 - OVERALL AND MOUNTING DIMENSIONS

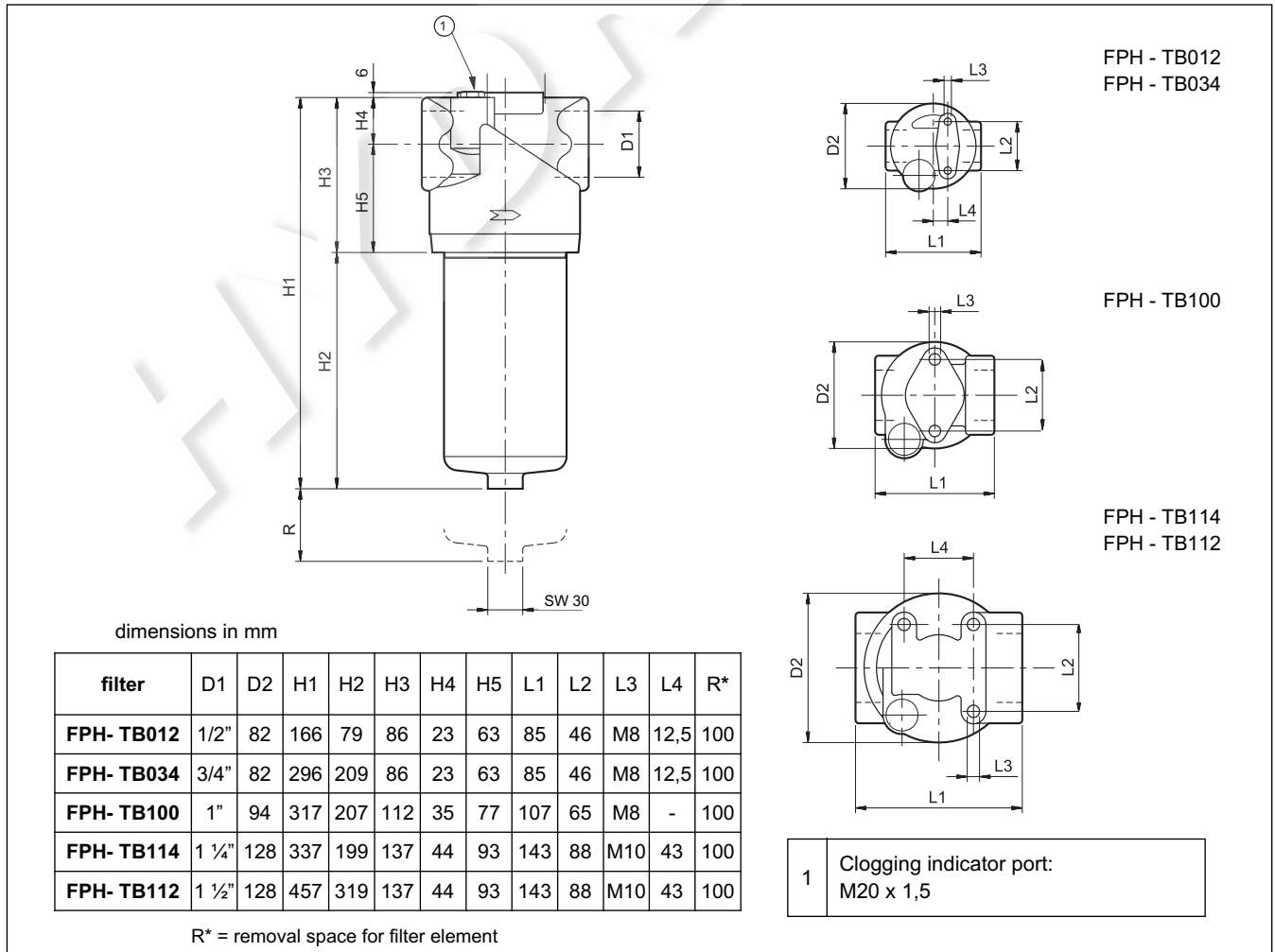

5 - CLOGGING INDICATORS

The filters are all designed to incorporate clogging indicators, which have to be ordered separately.

5.1 - Visual indicator for delivery filters

Identification code: **VPM/10**

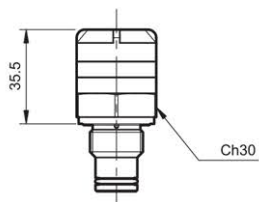

This indicator measures the differential pressure between the filter input and output.

The indicator is supplied with coloured bands, which informs you about the clogging condition of the filter element:

WHITE: efficient filter element $\Delta p < 5$ bar ($\pm 10\%$)

RED: the filter element has to be replaced $\Delta p > 5$ bar ($\pm 10\%$)

5.2 - Electric-visual indicator for delivery filters

Identification code: **EPM/10**

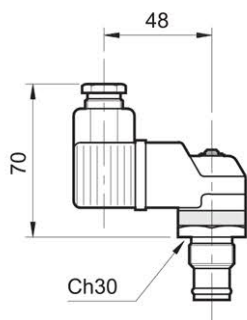

This indicator, apart from giving a visual indication, for example the VPM model, operates by switching an electric contact when the filter element has reached the clogging limit.

The contact can be wired in an open or closed condition (see the hydraulic symbol).

TECHNICAL SPECIFICATIONS

Differential operating pressure	bar	5
AC power supply		
Max. operating voltage	VAC	250 50/60 Hz
Max. load on the contacts (inductive or resistive)	A	1
DC power supply		
Max. operating voltage	VDC	125
Max. load on the contacts (with V at 30-50-75-125 VDC)	A	2 - 0,5 - 0,25 - 0,2 2 - 0,5 - 0,25 - 0,03
resistive		
inductive		
Electric connector	DIN 43650	
Class of protection according to CEI EN 60529 (atmospheric agents)	IP65	

6 - FILTER ELEMENTS

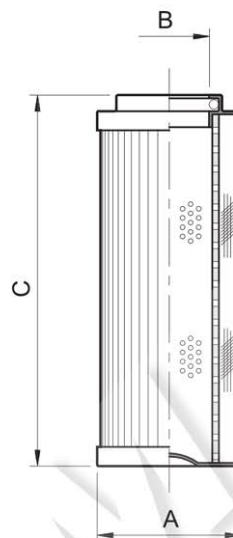

filter element code	ØA	ØB	C	Average filtering surface [cm ²]	
				H05	F12/F25
FPHE - 012	45	25	85	340	355
FPHE - 034	45	25	211	915	935
FPHE - 100	52	23,5	210	1785	1830
FPHE - 114	78	42,5	210	2695	3695
FPHE - 112	78	42,5	330	4325	5025

FILTER ELEMENT IDENTIFICATION CODE

F P H E - - - S / 10

Filter element for FPH filters

Nominal dimension:
012 = 1/2" **114** = 1 1/4"
034 = 3/4" **112** = 1 1/2"
100 = 1"

Filtration degree: H05 = fibre 5 µm
 F10 = fibre 10 µm
 F25 = fibre 25 µm

Standard filter element

Series N. (from 10 to 19 sizes and mounting dimensions remain unchanged)

N = NBR seals for mineral oils (standard)
V = FPM seals for special fluids (upon request)