

Part number:

**HYDROMA**

HYDRAULICKÉ SYSTÉMY

**HIDROMA  
SYSTEMS**

UKŁADY HYDRAULICZNE

**HYDROMA**

ГИДРАВЛИЧЕСКИЕ СИСТЕМЫ

Catalogue HY11-3500/UK

**Characteristics****Directional Control Valve  
Series D3W**

The NG10 direct operated directional control valve series D3W provides high functional limits up to 150 l/min in combination with a low, energy saving pressure drop.

The wide variety of options includes soft shift anchor tubes for smooth operation.

Versions with position control, additional surface protection and connector variants are shown in the following chapters.

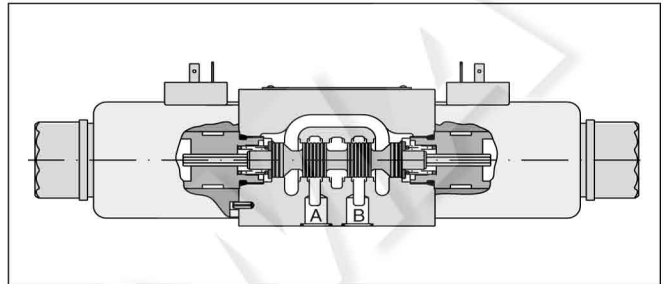
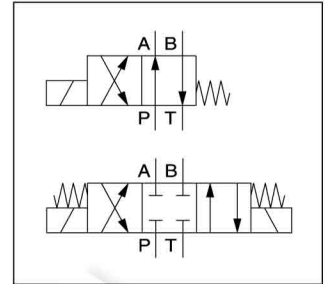
**Technical data**

General							
Design	Directional spool valve						
Actuation	Solenoid						
Size	DIN NG10 / CETOP 05 / NFPA D05						
Mounting interface	DIN 24340 A10 / ISO 4401 / CETOP RP 121-H / NFPA D05						
Mounting position	unrestricted, preferably horizontal						
Ambient temperature	[°C] -25...+60						
MTTF <sub>D</sub> value	[years] 150						
Weight	[kg] 4.8 (1 solenoid), 6.3 (2 solenoids)						
Vibration resistance	[g] 10 Sinus 5...2000 Hz acc. IEC 68-2-6 30 Random noise 20...2000 Hz acc. IEC 68-2-36 15 Shock acc. IEC 68-2-27						
Hydraulic							
Max. operating pressure	[bar] P, A B: 350; T: 210 (DC), 105 (AC)						
Fluid	Hydraulic oil according to DIN 51524						
Fluid temperature	[°C] -20 ... +70 (NBR: -25...+70)						
Viscosity permitted	[cSt] / [mm <sup>2</sup> /s] 2.8...400						
Viscosity recommended	[cSt] / [mm <sup>2</sup> /s] 30...80						
Filtration	ISO 4406 (1999); 18/16/13						
Flow max.	[l/min] 150 (DC); 115 (AC) (see shift limits)						
Leakage at 50 bar	[ml/min] Up to 20 per flow path, depending on spool						
Static / Dynamic							
Step response	see table response times						
Electrical characteristics							
Duty ratio	100 % ED; CAUTION: coil temperature up to 150 °C possible						
Max. switching frequency	[1/h] 10000						
Protection class	IP65 in accordance with EN 60529 (with correctly mounted plug-in connector)						
	Code	K	J	U	G	Y	T
Supply voltage / ripple	[V]	12 V =	24 V =	98 V =	205 V =	110 V at 50 Hz/ 120 V at 60 Hz	230 V at 50 Hz/ 240 V at 60 Hz
Tolerance supply voltage	[%]	±10	±10	±10	±10	±5	±5
Current consumption hold	[A]	3	1.5	0.35	0.18	0.8 / 0.72	0.4 / 0.36
Current consumption in rush	[A]	3	1.5	0.35	0.18	3.41 / 3.31	1.75 / 1.7
Power consumption hold	[W]	36	36	34	36	88 / 86	88 / 86
Power consumption in rush	[W]	36	36	34	36	375 / 397	385 / 408
Solenoid connection		Connector as per EN 175301-803, solenoid identification as per ISO 9461.					
Wiring min.	[mm <sup>2</sup> ]	3 x 1.5 recommended					
Wiring length max.	[m]	50 recommended					

With electrical connections the protective conductor (PE ↓) must be connected according to the relevant regulations.

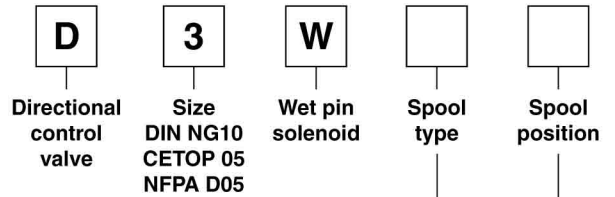

3 position spools	
Code	Spool type
	a 0 b
001	
002	
003	
004	
005	
006	
007	
008 <sup>1)</sup>	
009 <sup>1)</sup>	
010 <sup>2)</sup>	
011	
012	
014	
015	
016	
021 <sup>2)</sup>	
022 <sup>2)</sup>	
031 <sup>2)</sup>	
032 <sup>2)</sup>	
081 <sup>2)</sup>	
082 <sup>2)</sup>	
102 <sup>2)</sup>	

2 position spools	
Code	Spool type
	a b
020	
026	
030	
101 <sup>2)</sup>	

3 position spools			
Code	Spool position		
<b>C</b>			<b>3 positions.</b> Spring offset in position "0". Operated in position "a" or "b".
	Standard	Spool type 008, 009	
<b>E</b>	 Operated in position "a".	 Operated in position "b".	<b>2 positions.</b> Spring offset in position "0".
<b>F</b>	 Spring offset in position "b".	 Spring offset in position "a".	2 positions. Operated in position "0".
<b>K</b>	 Operated in position "b".	 Operated in position "a".	<b>2 positions.</b> Spring offset in position "0".
<b>M</b>	 Spring offset in position "a".	 Spring offset in position "b".	2 positions. Operated in position "0".

2 position spools			
Code	Spool position		
<b>B</b>			<b>2 positions.</b> Spring offset in position "b". Operated in position "a".
<b>D</b>			<b>2 positions.</b> Operated in position "a" or "b". No center or offset position.
<b>H</b>			<b>2 positions.</b> Spring offset in position "a". Operated in position "b".

<sup>1)</sup> Consider specific spool position.  
<sup>2)</sup> Only available for DC voltage.  
<sup>3)</sup> To be used in combination with rectifier plugs at 120 VAC / 230 VAC power supply.  
<sup>4)</sup> DC only.

**Ordering Code**



Seals



Solenoid voltage



Connector as per EN 175301-803, without plug (Please order plug separately)



Solenoid option



Shift response



Design series (not required for ordering)

Code	Shift response
<b>omit</b>	<b>Standard response</b>
S4 <sup>4)</sup>	orifice diameter 1.0 mm
S7 <sup>4)</sup>	orifice diameter 1.75 mm

Code	Solenoid option
<b>omit</b>	<b>manual override (Standard)</b>
T <sup>4)</sup>	without manual override

Code	Solenoid voltage
<b>K</b>	<b>12 V =</b>
<b>J</b>	<b>24 V =</b>
U <sup>3)</sup>	98 V =
G <sup>3)</sup>	205 V =
Y	110 V 50 Hz / 120 V 60 Hz
T	230 V 50 Hz / 240 V 60 Hz

Code	Seals
<b>N</b>	<b>NBR</b>
V	FPM

**Bold letters = Short-term availability**

Further spool types and solenoid voltages on request.

The flow curve diagram shows the flow versus pressure drop curves for all spool types. For each spool type, operating position and flow direction the relevant curve number is given in the table below.

Spool	Position b		Position a		Position 0					
	P->A	B->T	P->B	A->T	P->A	P->B	A->T	B->T	P->T	A->B
001	6	5	6	6	-	-	-	-	-	-
002	3	5	3	3	1	1	4	5	1	6
003	2	2	3	1	-	-	3	-	-	-
004	5	4	4	4	-	-	8	8	-	9
005	2	2	2	2	3	-	-	-	-	-
006	1	2	1	3	2	2	-	-	-	3
007	2	1	2	2	-	1	-	2	3	-
010	2	-	2	-	-	-	-	-	-	-
011	2	2	2	2	-	-	11	11	-	11
012	1	2	2	2	10	10	10	10	11	11
014	1	2	2	2	1	-	2	-	3	-
015	2	1	2	2	-	-	-	3	-	-
016	2	2	1	2	-	2	-	-	-	-
020	6	6	5	7	-	-	-	-	-	-
026	5	-	5	-	-	-	-	-	-	-
030	4	5	3	5	-	-	-	-	-	-
	P->B	A->T	P->A	B->T	P->A	P->B	A->T	B->T	P->T	A->B
008	8	7	7	6	-	-	-	-	9	-
009	4	4	5	8	-	-	-	-	9	-
	Position b			Position a						
	P->A	P->B	A->B	P->B	A->T					
021	2	4	8	3	2					
	P->A	B->T	P->A		P->B	A->B				
022	3	2	3		2	8				

**Flow curve diagram**

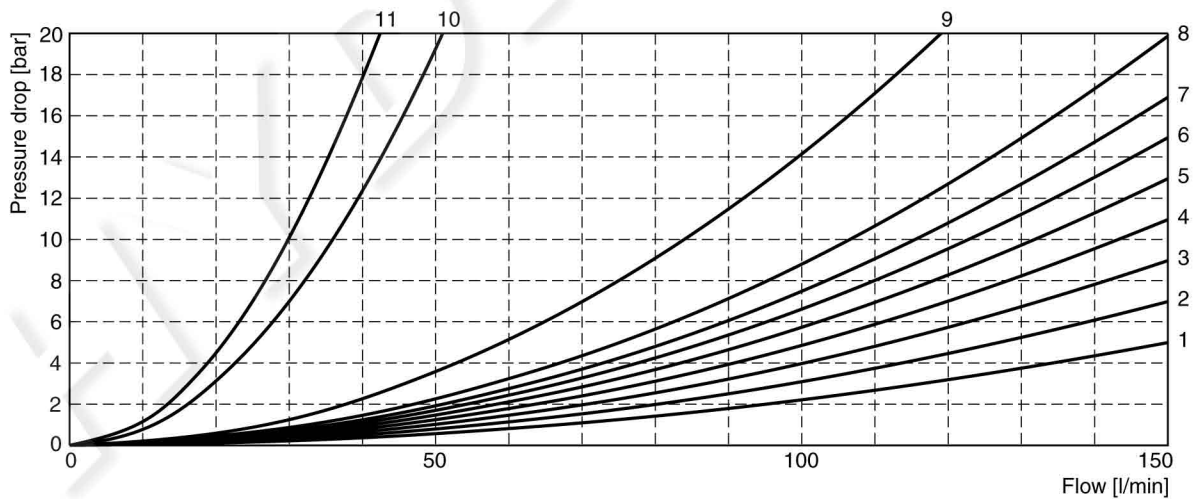

All characteristic curves measured with HLP46 at 50 °C.

The diagrams below specify the shift limits for valves with DC and AC solenoids. Valves with spool position "F" or "M" can only be operated up to 70 % of the limits. The specifications apply to a viscosity of 40 mm<sup>2</sup>/s and bal-

anced flow conditions. The shift limits can be considerably lower at unbalanced flow conditions. To avoid flow rates beyond the shift limits, a plug-in orifice can be inserted in the P-port.

**Shift limits, DC voltage**

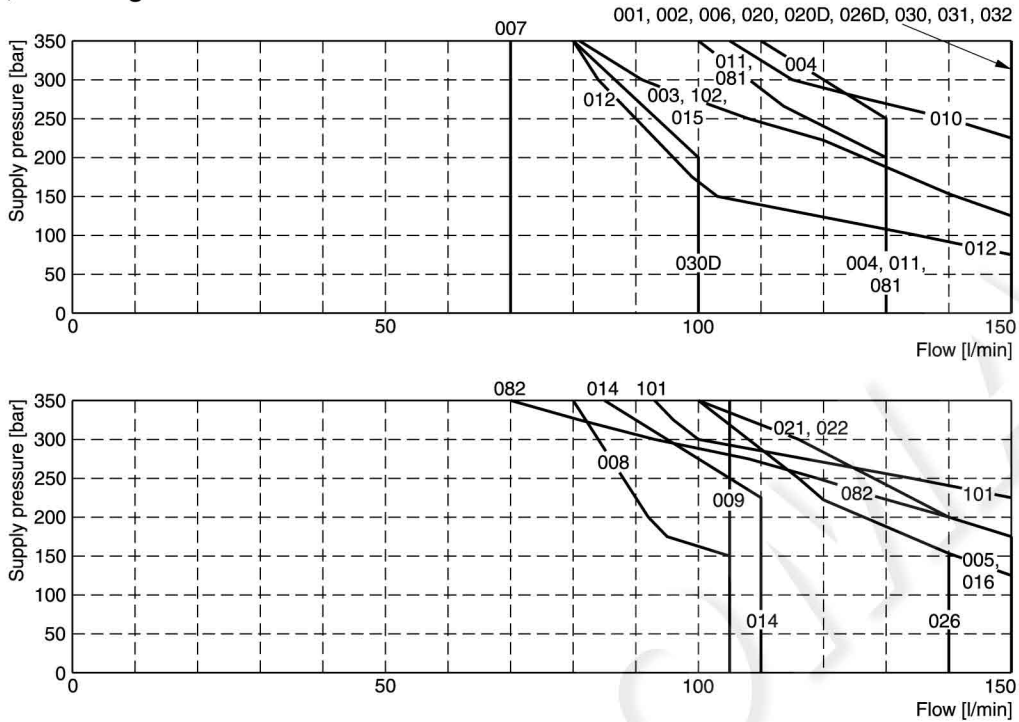

Measured with HLP46 at 50 °C, 90 % U<sub>nom</sub> and warm solenoids.

**Shift limits, AC voltage**

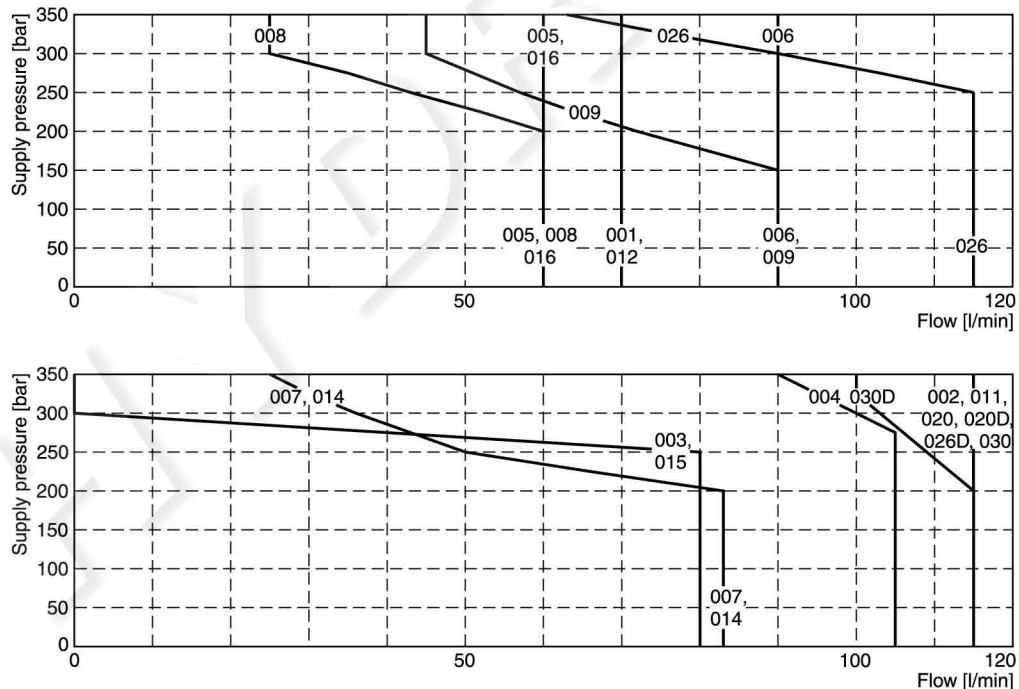

Measured with HLP46 at 50 °C, 95 % U<sub>nom</sub> and warm solenoids.

**Shift limits soft shift**

The diagrams below specify the shift limits. Valves with spool position “F” or “M” can only be operated up to 70 % of the limits. The specifications apply to a viscosity of 40 mm<sup>2</sup>/s and balanced flow conditions. The shift limits can

be considerably lower at unbalanced flow conditions. To avoid flow rates beyond the shift limits, a plug-in orifice can be inserted in the P-port.

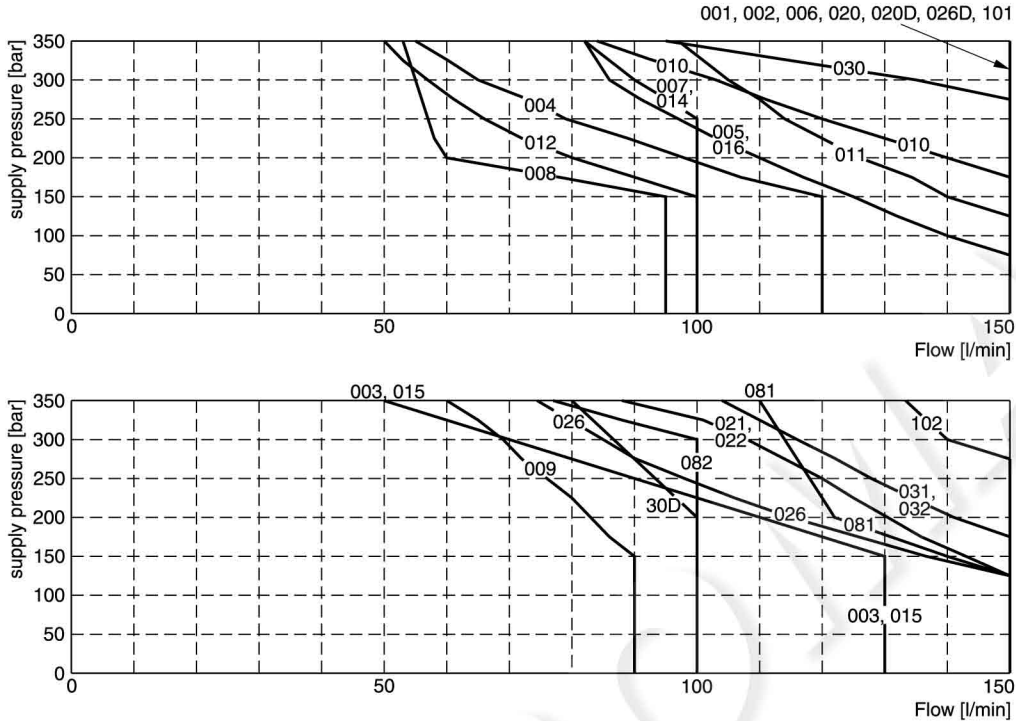

Measured with HLP46 at 50 °C, 90 % U<sub>nom</sub> and warm solenoids.

**Response times D3W Soft Shift**

Code	Orifice size	Energize	De-energize
(Standard)	—	105 ms (DC) 21 ms (AC)*	85 ms (DC) 35 ms (AC)*
S4	1.0 mm	320 ms	550 ms
S7	1.75 mm	160 ms	370 ms

Step response times were obtained under the following conditions: HLP46 at 50 °C with the valve operating at 175 bar and 65 l/min. Published response times are nominal and may vary with spool, flow, pressure and temperature.

**Acceleration for different orifice sizes (archived against a valve without soft shift)**

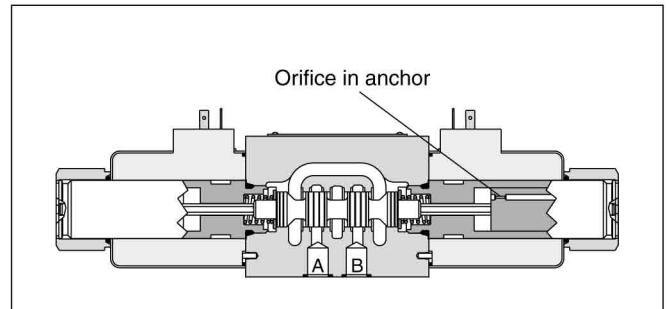
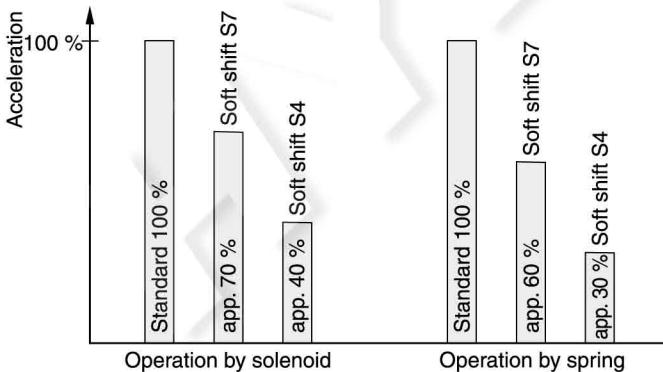

For even softer shifting, the proportional spools 081, 082, 101 and 102 can be used.

\* For AC input and soft shift use rectifier plug.

**Dimensions**

**Interface EN 175301-803, DC solenoid  
B, E, F-style**

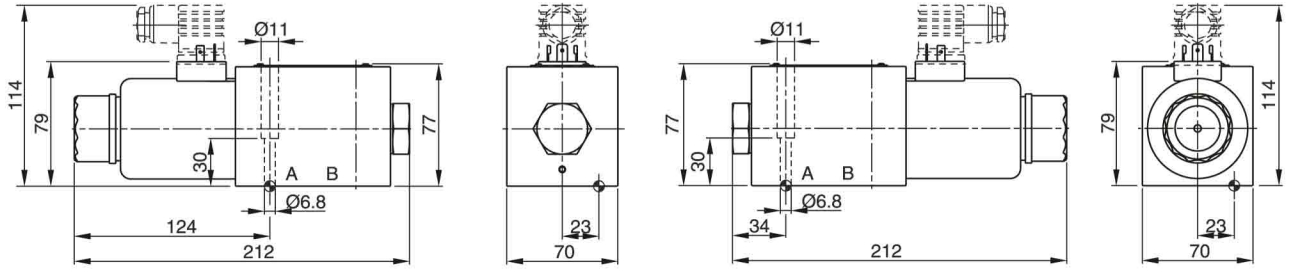

**C, D-style**

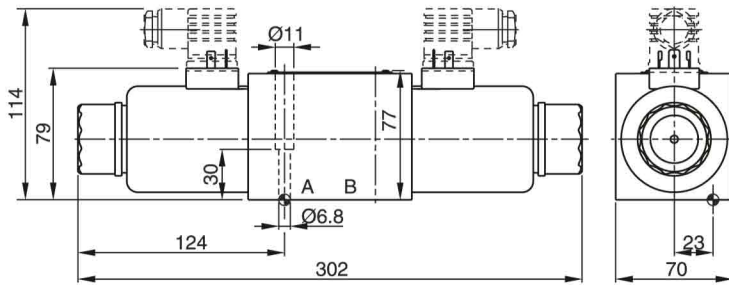



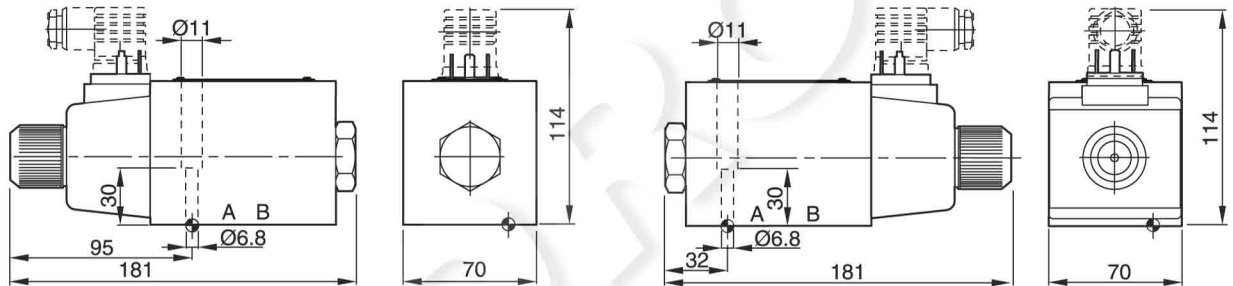

**Interface EN 175301-803, AC solenoid  
B, E, F-style**

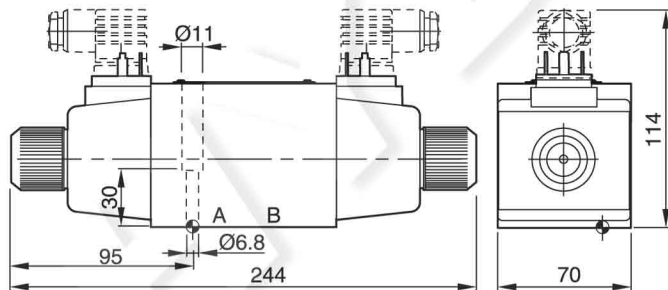

**C, D-style**

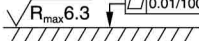

Surface finish	 Kit	 Kit	 Kit	 Kit
$\sqrt{R_{max} 6.3}$ $\square 0.01/100$ 	BK385	4x M6x40 ISO 4762-12.9	13.2 Nm ±15 %	<b>NBR: SK-D3W-30</b> FPM: SK-D3W-V-30

The space necessary to remove the plug per EN 175301-803, design type AF is at least 15 mm.  
The torque for the screw M3 of the plug has to be 0.5 to 0.6 Nm.