

Part number:

078-10019

HYDROMA

HYDRAULICKÉ SYSTÉMY

**HIDROMA
SYSTEMS**

UKŁADY HYDRAULICZNE

HYDROMA

ГИДРАВЛИЧЕСКИЕ СИСТЕМЫ

11.1 - RUBINETTO A SFERA A 2 VIE 11.1 - BALL VALVES 2 WAYS

TIPO/TYPE
RS 2



SCHEMA IDRAULICO
HYDRAULIC DIAGRAM

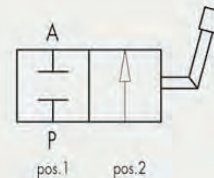

IMPIEGO:

Valvole utilizzate per aprire o chiudere il flusso di olio di un impianto anche alla massima pressione.

MATERIALI E CARATTERISTICHE:

Corpo: acciaio zincato

Componenti interni: acciaio rettificato e cromato

Guarnizioni: BUNA N standard e POM

Tenuta: a sfera e guarnizioni. Non ammette trafilamenti

MONTAGGIO:

Collegare indifferentemente A e P al ramo di cui si vuole bloccare il flusso. Con leva a 90° (pos. 1) il flusso è bloccato, con leva in linea (pos. 2) il flusso è libero.

A RICHIESTA:

- Fori di fissaggio (CODICE/FF)

USE AND OPERATION:

These valves are used to open or close oil flow in a circuit even with maximum pressure

MATERIALS AND FEATURES:

Body: zinc-plated steel

Internal parts: ground and chromium-plated steel

Seals: BUNA N standard and POM seals

Ball type and seals: any leakage

APPLICATIONS:

Connect indifferently A or P to the ports where flow has to be blocked. Flow is blocked with lever at 90° (position 1) and free with lever in line (position 2).

ON REQUEST:

- fixing holes (CODE/FF)

CONNESSIONE FEMMINA GAS DIN/ISO 228 BSP
DIN/ISO 228 BSP FEMALE CONNECTION

CODICE CODE	SIGLA TYPE	MAX FLOW	PN	DN	A-P	L	L1	L2	L3	L4	L5	ØG	H	H1	Ø	PESO WEIGHT Kg
		l/min	Bar	mm	GAS	mm	mm	mm	mm	mm	mm	mm	mm	mm	mm	
V0830	RS 2 VIE 1/4"	25	500	6	G 1/4"	42	71	110	14	25	5	5,5	35	92	30	0,50
V0840	RS 2 VIE 3/8"	35	500	10	G 3/8"	44	73	110	17	31	5	5,5	40	97	35	0,65
V0850	RS 2 VIE 1/2"	60	500	13	G 1/2"	48	83	110	18	34	6	6,5	43	100	37	0,75
V0860	RS 2 VIE 3/4"	100	400	20	G 3/4"	63	95	180	23	46	6	8,5	55	110	45	1,40
V0870	RS 2 VIE 1"	180	350	25	G 1"	67	112	180	29	49	6	8,5	65	120	55	2,20
V0871	RS 2 VIE 1" 1/4	180	350	25	G 1" 1/4	67	120	180	29	49	6	8,5	65	120	55	2,25
V0874	RS 2 VIE 1" 1/2	180	350	25	G 1" 1/2	67	124	180	29	49	6	8,5	65	120	55	2,35

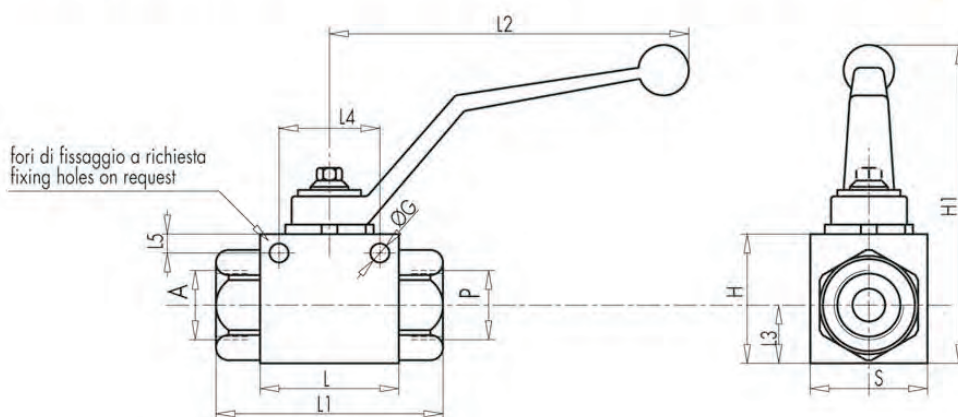

DXF



CONNESSIONE SERIE LEGGERA DIN 2353
DIN 2353 LIGHT SERIES CONNECTION

CODICE CODE	SIGLA TYPE	MAX FLOW	PN	DN	A-P	L	L1	L2	L3	L4	L5	L6	L7	ØG	H	H1	Ø	PESO WEIGHT Kg
		l/min	Bar	mm	mm	mm	mm	mm	mm	mm	mm	mm	mm	mm	mm	mm	mm	
RS2-6L	RS 2 VIE M12X1,5	25	500	6	M12X1,5	42	76	110	14	25	5	10	6	5,5	35	92	30	0,50
RS2-8L	RS 2 VIE M14X1,5	25	500	6	M14X1,5	42	76	110	14	25	5	10	8	5,5	35	92	30	0,50
RS2-10L	RS 2 VIE M16X1,5	25	500	6	M16X1,5	42	76	110	14	25	5	11	10	5,5	35	92	30	0,50
RS2-10L	RS 2 VIE M16X1,5	35	500	10	M16X1,5	44	76	110	17	31	5	11	10	5,5	40	97	35	0,65
RS2-12L	RS 2 VIE M18X1,5	35	500	10	M18X1,5	44	79	110	17	31	5	11	12	5,5	40	97	35	0,65
RS2-15L	RS 2 VIE M22X1,5	60	500	13	M22X1,5	48	87	110	18	34	6	12	15	6,5	43	100	37	0,75
RS2-18L	RS 2 VIE M26X1,5	60	500	13	M26X1,5	48	87	110	18	34	6	12	18	6,5	43	100	37	0,75
RS2-22L	RS 2 VIE M30X2	100	500	20	M30X2	63	110	180	23	46	6	14	22	8,5	55	110	45	1,40
RS2-28L	RS 2 VIE M36X2	180	350	25	M36X2	67	115	180	29	49	6	14	28	8,5	65	120	55	2,20
RS2-35L	RS 2 VIE M45X2	180	350	25	M45X2	67	119	180	29	49	6	16	35	8,5	65	120	55	2,15
RS2-42L	RS 2 VIE M52X2	180	350	25	M52X2	67	120	180	29	49	6	16	42	8,5	65	120	55	2,15